



User Guide

Quality, Design and Innovation



home.liebherr.com/fridge-manuals



LIEBHERR

Appliance at a glance

Contents

1	Appliance at a glance	2
1.1	Scope of delivery.....	2
1.2	Overview of the appliance and equipment.....	3
1.3	SmartDevice.....	3
1.4	Appliance range of use.....	3
1.5	Conformity.....	4
1.6	SVHC substances according to REACH regulation.....	4
1.7	EPREL database.....	4
1.8	Spare parts.....	4
2	General safety instructions	4
3	Functionality of the Touch display	5
3.1	Navigation and symbol explanation.....	5
3.2	Menus.....	6
3.3	Sleep mode.....	6
4	Putting into operation	7
4.1	Switching on appliance (first use).....	7
5	Storage	7
5.1	Information regarding storage.....	7
5.2	Storage sketches.....	7
6	Saving energy	12
7	Controls	12
7.1	Control and display elements.....	12
7.2	Appliance functions.....	13
7.2.1	Notes on the appliance functions.....	13
7.2.2	Switching appliance on and off	13
7.2.3	WiFi	14
7.2.4	Temperature	15
7.2.5	Temperature unit	15
7.2.6	SabbathMode	15
7.2.7	HumiditySelect *.....	16
7.2.8	HumidityControl *.....	16
7.2.9	Lighting intensity *.....	17
7.2.10	Display brightness	17
7.2.11	Door alarm	17
7.2.12	Alarm Sound.....	18
7.2.13	Key Sound.....	18
7.2.14	Display lock	18
7.2.15	Display PIN	19
7.2.16	Language	20
7.2.17	Device information	20
7.2.18	Software	20
7.2.19	Reminder	20
7.2.20	Demo mode	21
7.2.21	Resetting to factory settings	21
7.3	Messages.....	22
7.3.1	Warnings.....	22
7.3.2	Reminder.....	23
8	Features	23
8.1	Safety lock.....	23
8.2	Labels.....	23
9	Maintenance	24
9.1	Air exchange through the FreshAir activated charcoal filter.....	24
9.2	Cleaning the appliance.....	24
10	Customer help	25
10.1	Technical specifications.....	25
10.2	Operating noises.....	25
10.3	Technical fault.....	26
10.4	Customer Service.....	27
10.5	Model plate.....	27
11	Shutting down	27
12	Disposal	27
12.1	Preparing appliance for disposal.....	27
12.2	Disposing of the appliance in an environmentally friendly manner.....	27

The manufacturer is continually working on the further development of all types and models. Please be aware that we reserve the right to make changes to the shape, equipment and technology.







Symbol	Explanation
	Read instructions Please read the information in these instructions carefully to understand all of the benefits of your new appliance.
	Additional information on the Internet The digital manual with additional information and in other languages can be found via the QR code on the front of the manual or by entering the service number at home.liebherr.com/fridge-manuals . The service number can be found on the serial tag: 
	Check appliance Check all parts for transport damage. If you have any complaints, please contact your agent or customer service.
	Differences These instructions apply to a range of models, so differences are possible. Sections that apply to certain models only are marked with an asterisk (*).
	Instructions and results Instructions are marked with a ▶. Results are marked with a ▷.
	Videos Videos about the appliances are available on the YouTube channels of Liebherr-Hausgeräte.

Fig. Example illustration

Open source licences:

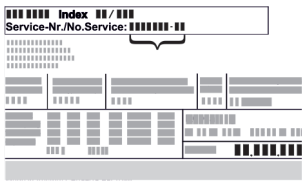
The appliance contains software components that use open source licences. Information on the open source licences used can be found here: home.liebherr.com/open-source-licences

These operating instructions apply to:

WPbl(i)	42.. / 46.. / 50.. / 52..
WSbl(i)	42.. / 46.. / 50.. / 52.. / 77..

1 Appliance at a glance

1.1 Scope of delivery

Check all parts for transport damage. Contact your dealer or customer service in the event of complaints. (see 10.4 Customer Service)

Your new appliance comes with the following parts:

- Standalone appliance
- Features (depending on the model)

- Installation materials (depending on the model)
- "Quick Start Guide"
- "Installation Guide"*
- Service Brochure



More information about SmartDevice: smartdevice.liebherr.com

Purchasing the SmartDeviceBox in the Liebherr-Hausgeräte store:* home.liebherr.com/shop/de/deu/smartdevicebox.html*

Downloading the SmartDevice app:



After installing and configuring the SmartDevice, you can connect your appliance to the WiFi using the SmartDevice app and the WiFi appliance function (see 7.2.3 WiFi).

1.2 Overview of the appliance and equipment

WPbl 42.. / 46.. / 50..
WPbli 50.. / 52..

WSbl 42.. / 46.. / 50..
WSbli 50.. / 52.. / 77..

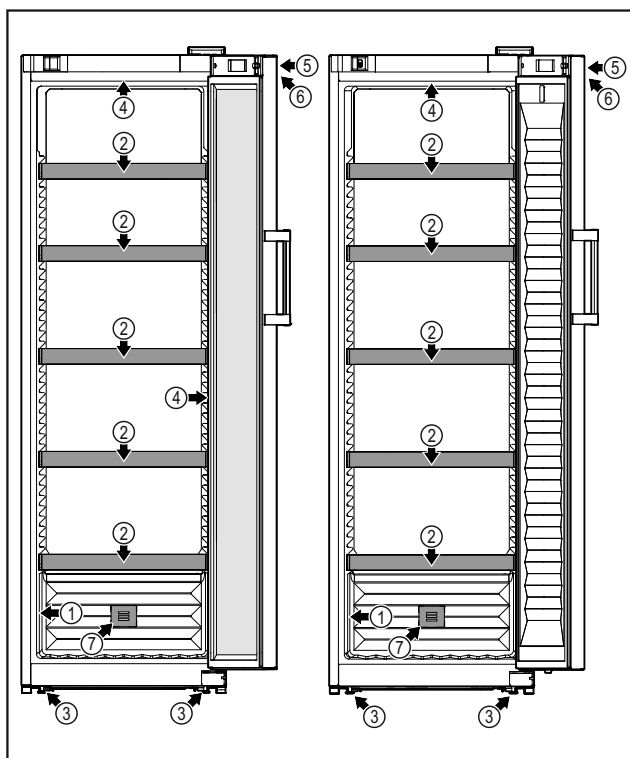

Fig. 1 Example illustration

- | | |
|------------------------|--|
| (1) Serial tag | (5) Lock |
| (2) Bottle shelf | (6) Control elements and temperature display |
| (3) Adjusting feet | (7) FreshAir activated charcoal filter |
| (4) Interior lighting* | |

1.3 SmartDevice

SmartDevice is the networking solution for your wine storage cabinet.

If your appliance SmartDevice-enabled or compatible, you can quickly and easily connect your appliance to your WiFi. With the SmartDevice app, you can operate your appliance from a mobile device. Additional functions and setting options are available in the SmartDevice SmartDevice app.

SmartDevice-enabled appliance:* Your appliance is capable of being a SmartDevice. To be able to connect your device to WiFi, you need to download the SmartDevice app.*

SmartDevice-compatible appliance:* Your appliance is compatible for use with the SmartDeviceBox. You must first purchase and install the SmartDeviceBox. In order to connect your appliance to the WiFi, you need to download the SmartDevice app.*

Note

The SmartDevice function is not available in the following countries: Russia, Belarus, Kazakhstan.

You cannot use the SmartDeviceBox.*

1.4 Appliance range of use

Intended use

The appliance is only suitable for storing wine in a domestic or domestic-like environment. This includes, for example, using

- in staff kitchens, bed and breakfast establishments,
- by guests in country houses, hotels, motels and other accommodation,
- for catering and similar services in the wholesale trade.

The appliance is not suitable for freezing food;

The appliance is not suitable as a built-in unit.

All other types of use are not permitted.

Foreseeable misuse

The following applications are expressly forbidden:

- Storing and refrigerating medicines, blood plasma, laboratory preparations or similar substances and products based on the Medical Device Directive 2007/47/EC
- Use in areas at risk of explosions

Misusing the appliance may lead to damage to the goods stored or they may spoil.

Climate classifications

Depending on the climate classification the appliance is designed to operate in restricted

General safety instructions

ambient temperatures. The climate classification applying to your appliance is printed on the rating plate.

Note

► Keep to the specified ambient temperatures in order to guarantee that the appliance works properly.

Climate classification	for ambient temperatures of
SN	10 °C to 32 °C
N	16 °C to 32 °C
ST	16 °C to 38 °C
T	16 °C to 43 °C
SN-ST	10 °C to 38 °C
SN-T	10 °C to 43 °C

1.5 Conformity

The refrigerant circuit has been tested for leaks. The appliance complies with the applicable safety regulations and with the corresponding directives.

For the market:* EU The appliance complies with directive 2014/53/EU.*

For the market:* GB The appliance complies with Radio Equipment Regulations 2017 SI 2017 No. 1206.*

The full text of the EU Declaration of Conformity is available on the following website: www.Liebherr.com

The BioFresh compartment meets the requirements of a cold storage compartment as set out in DIN EN 62552:2020.

1.6 SVHC substances according to REACH regulation

You can check whether your appliance contains SVHC substances according to REACH regulation at the following link: home.liebherr.com/de/deu/de/liebherr-erleben/nachhaltigkeit/umwelt/scip/scip.html

1.7 EPREL database

Details about energy labelling and ecodesign requirements will be available on the European product database (EPREL) from 1st March 2021. You can access the product database at the following link: <https://eprel.ec.europa.eu/> You will be asked to enter the model ID. You can find the model ID on the nameplate.

1.8 Spare parts

The spare parts availability for functional parts and stockable parts of the equipment is 15 years.

2 General safety instructions

Please keep these operating instructions in a safe place so you can refer back to them at any time.

If you pass the appliance on, please hand these operating instructions to the next user.

Read these operating instructions carefully before use to ensure safe and correct use of the appliance. Follow the instructions, safety instructions and warning messages included at all times. They are important for ensuring you can operate and install the appliance safely and without any problems.

Danger for the user:

- This device can be used by children and people with impaired physical, sensory or mental abilities or with a lack of experience and knowledge provided that they are supervised or have received instruction in the safe use of this device, and about the resulting hazards.

Children must not play with this appliance. Cleaning and user maintenance work must not be carried out by children without adult supervision. Children aged between 3 and 8 are allowed to load and unload the appliance. Children below the age of 3 must be kept away from the appliance unless they are under continuous adult supervision.

- The socket must be easily accessible so that the appliance can be disconnected quickly from the electricity in an emergency. It must not be located in the area behind the appliance.
- When disconnecting the appliance from the supply, always take hold of the plug. Do not pull the cable.
- In the event of a fault pull out the mains plug or deactivate the fuse.
- Do not damage the mains power cable. Do not operate the appliance with a defective mains power cable.
- Only customer service or other specially trained staff may repair or perform other operations on the appliance.
- Only assemble, connect and dispose of the appliance according to the instructions.

Fire hazard:

- The coolant used (information on the model plate) is ecofriendly but also flammable. Any leaking coolant may ignite.
 - Do not damage the refrigerant circuit pipes.
 - Do not handle ignition sources inside the appliance.

Functionality of the Touch display

- Do not use electrical appliances inside the appliance (e.g. steam cleaners, heaters, ice cream makers, etc.).
- If the refrigerant leaks: remove any naked flames or ignition sources from the vicinity of the leakage point. Properly air the room. Inform customer services.
- Do not store explosives or sprays using combustible propellants such as butane, propane, pentane, etc. in the appliance. To identify these spray cans, look for the list of contents printed on the can, or a flame symbol. Gases possibly escaping may ignite due to electrical components.
- Keep burning candles, lamps and other items with naked flames away from the appliance so that they do not set the appliance on fire.
- Please be sure to store alcoholic drinks or other packaging containing alcohol in tightly closed containers. Any alcohol that leaks out may be ignited by electrical components.

Danger of tipping and falling:

- Do not misuse the plinth, drawers, doors etc. as a step or for support. This applies particularly to children.

Danger of food poisoning:

- Do not consume food which has been stored too long.

Danger of frostbite, numbness and pain:

- Avoid prolonged skin contact with cold surfaces or refrigerated/frozen goods or take protective measures, e.g wear gloves.

Danger of injury and damage:

- Hot steam can lead to injury. Do not use electrical heating or steam cleaning equipment, open flames or defrosting sprays to defrost.
- Do not use sharp implements to remove the ice.

Risk of crushing:

- Do not hold the hinge when opening and closing the door. Fingers may get caught.

Symbols on the appliance:



This symbol may be located on the compressor. It relates to the oil in the compressor and makes reference to the risk that: Swallowing or inhaling can be fatal. This advice is only relevant to recycling. There is no danger in normal operation.



This symbol is located on the compressor and indicates the danger of flammable materials. Do not remove the sticker.



This or a similar sticker may be located on the rear of the appliance. This sticker indicates that there are vacuum insulation panels (VIP) or perlite panels in the door and/or housing. This advice is only relevant to recycling. Do not remove the sticker.

Please note the warning messages and other specific advice in the other chapters:

	DANGER	indicates an immediately hazardous situation which will lead to death or serious injuries if it is not avoided.
	WARNING	indicates a hazardous situation which may lead to death or serious injuries if it is not avoided.
	CAUTION	indicates a hazardous situation which may lead to minor or moderate injuries if it is not avoided.
	NOTICE	indicates a hazardous situation which may lead to damage to property if it is not avoided.
	Note	indicates useful instructions and tips.

3 Functionality of the Touch display







You operate your appliance using the Touch display. You select appliance functions in the Touch display (hereafter referred to as display) by tapping them. If you do not perform any action on the display for 10 seconds, the display either jumps back to the higher-level menu or directly to the status display.

3.1 Navigation and symbol explanation

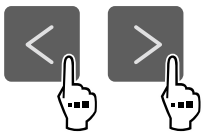
In the illustrations, different symbols are used to navigate the display. The following table describes these symbols.

Symbol	Description
	Press the Next navigation arrow: Navigates to the next option in the menu.
	Press the Back navigation arrow: Jumps back one option in the menu.
	Press and hold the Back navigation arrow for 3 seconds: Jumps back to the status display in the main menu or from the Settings menu.

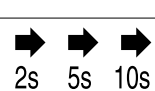
Functionality of the Touch display



Symbol	Description
	Press the navigation arrow several times in succession: Navigates in the menu to the desired function.
	Press the Confirm symbol: Activates/deactivates function. Opens submenu.
	Press the Confirm symbol together with the back icon: Jumps back one menu level.
	Arrow with clock: It takes more than 10 seconds for the following message to appear in the display.
	Arrow with a time indication: It takes the specified amount of time until the following message appears in the display.
	“Open Settings menu” symbol: Navigates to the Settings menu and opens the settings menu. If necessary: Navigate to the desired function in the Settings menu. (see 3.2.1 Opening the Settings menu)
	“Open Advanced menu” symbol: Navigates to the Advanced menu and opens the advanced menu. If necessary: Navigate to the desired function in the Advanced menu. (see 3.2.2 Opening the Advanced menu)
No action for 10 seconds	If you do not perform any action on the display for 10 seconds, the display either jumps to the higher-level menu or directly to the status display.
Opening door and closing it again	If you open the door and immediately close it again, the display jumps directly back to the status display.

Note: Illustrations of the display are shown in the English version.

3.2 Menus

The appliance functions can be found in various menus.

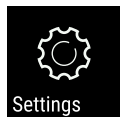
Menu	Description
Main menu	When you switch the appliance on, you are automatically in the main menu. From here you can navigate to the most important appliance functions, to the Settings menu and to the Advanced menu.

Menu	Description
 Settings menu	The Settings menu contains additional appliance functions for setting up your appliance. (see 3.2.1 Opening the Settings menu)
 Advanced menu	The advanced menu contains special appliance functions for setting up your appliance. Access to the Advanced menu is protected by the numerical code 151 . (see 3.2.2 Opening the Advanced menu)

3.2.1 Opening the Settings menu

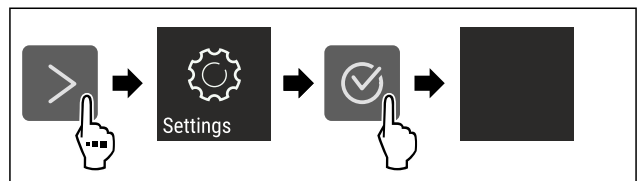

Fig. 2 Example illustration

- ▶ Carry out action steps according to the illustration.
- ▶ Settings menu is open.
- ▶ If necessary: Navigate to the desired function.

3.2.2 Opening the Advanced menu

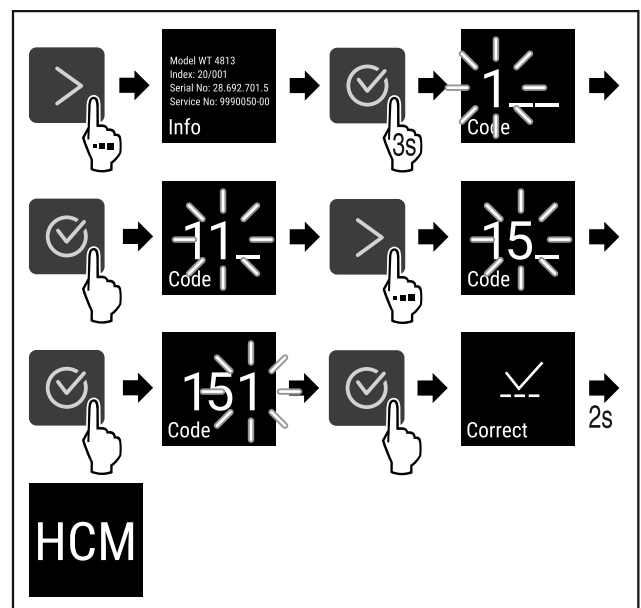

Fig. 3 Access with numerical code 151

- ▶ Carry out action steps according to the illustration.
- ▶ The expanded menu is open.
- ▶ If necessary: Navigate to the desired function.

3.3 Sleep mode

If you do not touch the display for 1 minute, the display switches to sleep mode. In sleep mode, the display brightness is dimmed.

3.3.1 Ending sleep mode

- ▶ Press any navigation key.
- ▶ Sleep mode is ended.

4 Putting into operation

4.1 Switching on appliance (first use)

Make sure that the following requirements are fulfilled:

- ❑ The appliance has been installed and connected in accordance with the installation instructions.
- ❑ All adhesive strips, adhesive and protective films and transport locks are removed from inside and on the appliance.
- ❑ All marketing leaflets are removed from the drawers.
- ❑ You are familiar with the functionality of the Touch display. (see 3 Functionality of the Touch display)

Switch on the appliance using the Touch display:

- ▶ If the display is in sleep mode: Press the confirmation symbol.
- ▶ Carry out action steps according to the illustration.

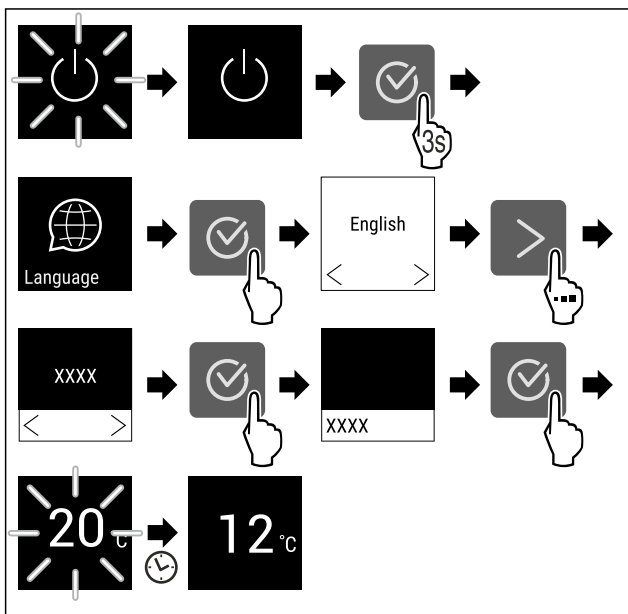

Fig. 4 Example illustration

- ▶ The status display appears. (see 7.1 Control and display elements)
- ▶ The appliance cools to the temperature set at the factory.
- ▶ The appliance starts in demo mode (status display with DEMO appears): If the appliance starts in demo mode, you can deactivate demo mode within the next 5 minutes. (see 7.2.20 Demo mode)

More information:

- Start the SmartDevice for the first time. (see 1.3 Smart-Device) and (see 7.2.3 WiFi)

Note

Accessories can be purchased from the Liebherr-Hausgeräte store at home.liebherr.com/shop/de/deu/zubehor.html.

5 Storage

5.1 Information regarding storage



WARNING

Risk of fire

- ▶ Do not use any electrical appliances in the food area of the appliance unless recommended by the manufacturer.

Note

The energy consumption increases and the cooling power goes down if ventilation is not sufficient.

- ▶ Always keep air slots clear.

Observe the following specifications for storage:

- Keep the air vents on the fan free.
- Keep liquids in closed containers.
- Position storage shelves according to the height required.
- Observe maximum load weight. (see 10.1 Technical specifications)

5.2 Storage sketches

5.2.1 WPbl 42.. / WSbl 42..

The maximum number of bottles is only possible with the specified spacings.

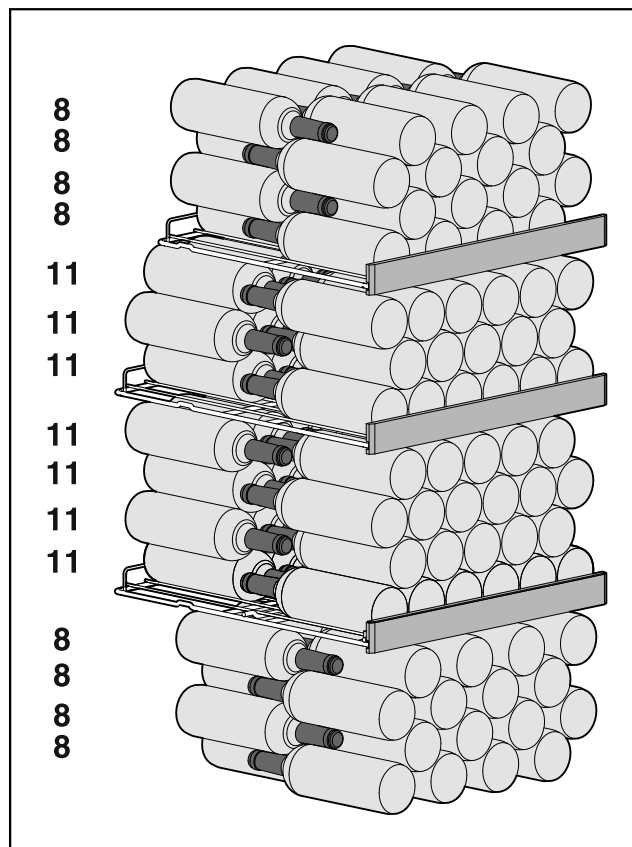

Fig. 5 Total 141 bottles

Storage

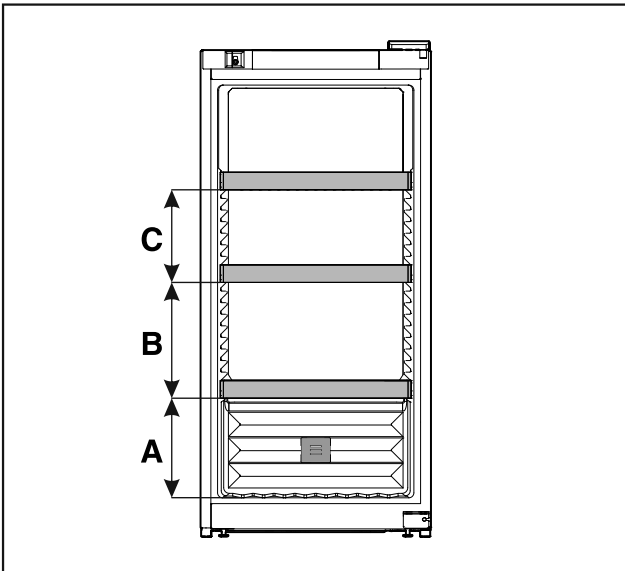

Fig. 6 Grid shelf spacing

	WPbl 42.. / WSbl 42..
A	260 mm
B	300 mm
C	240 mm

5.2.2 WPbl 46.. / WSbl 46..

The maximum number of bottles is only possible with the specified spacings.

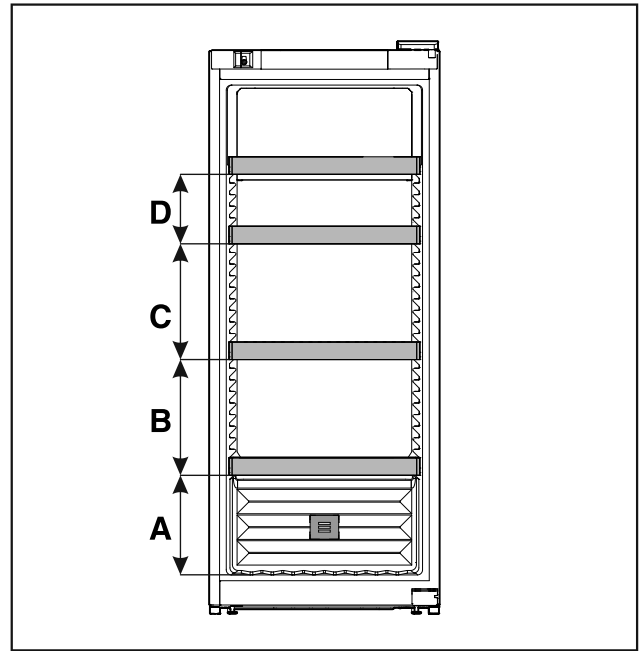

Fig. 8 Grid shelf spacing

	WPbl 46.. / WSbl 46..
A	260 mm
B	300 mm
C	300 mm
D	180 mm

5.2.3 WPbl 50.. / WSbl 50..

The maximum number of bottles is only possible with the specified spacings.

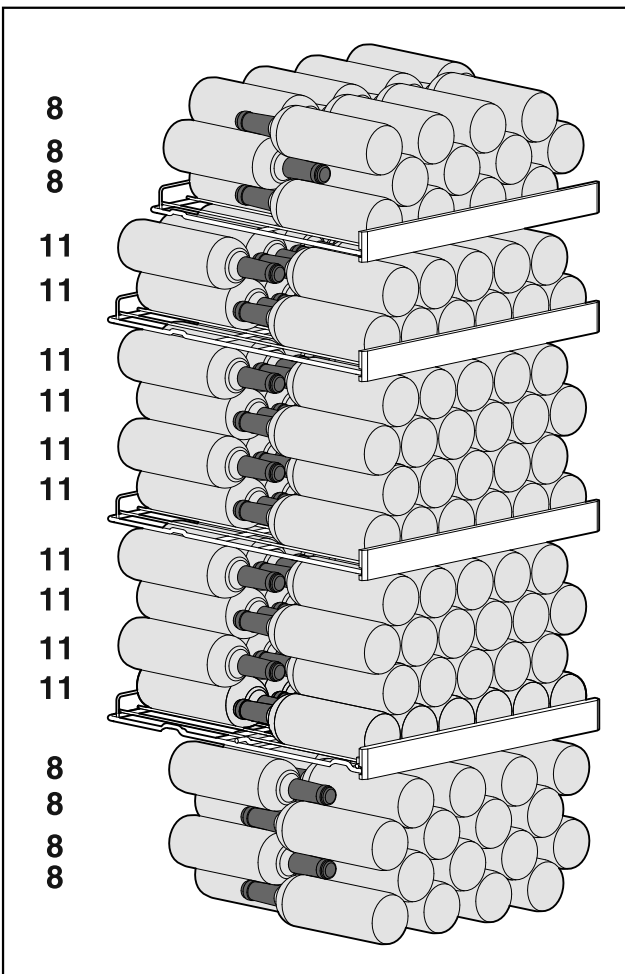

Fig. 7 Total 166 bottles

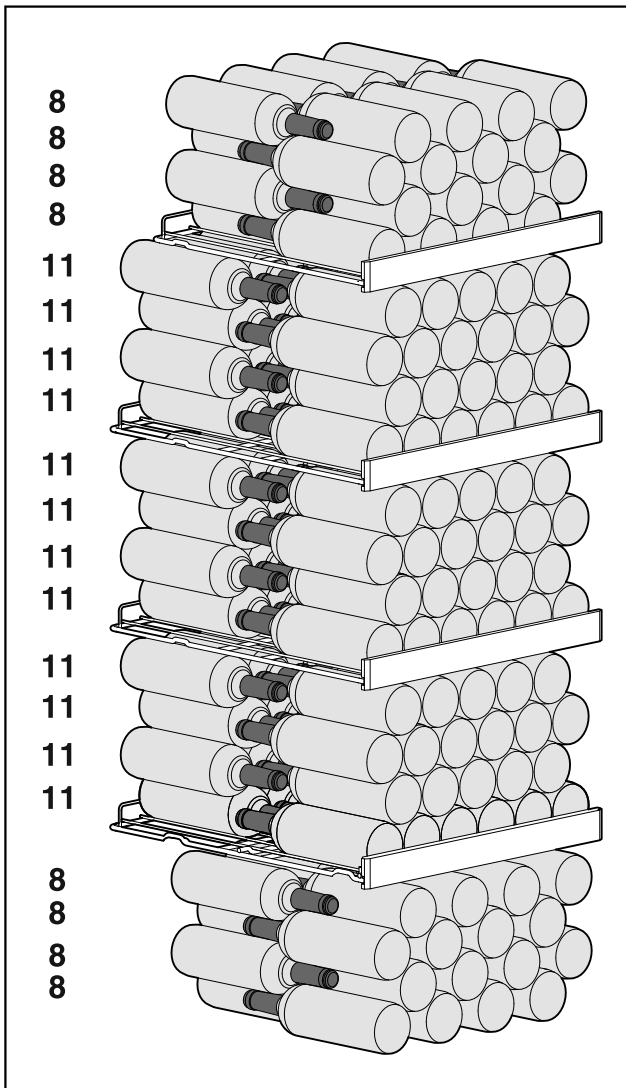

Fig. 9 Total 196 bottles

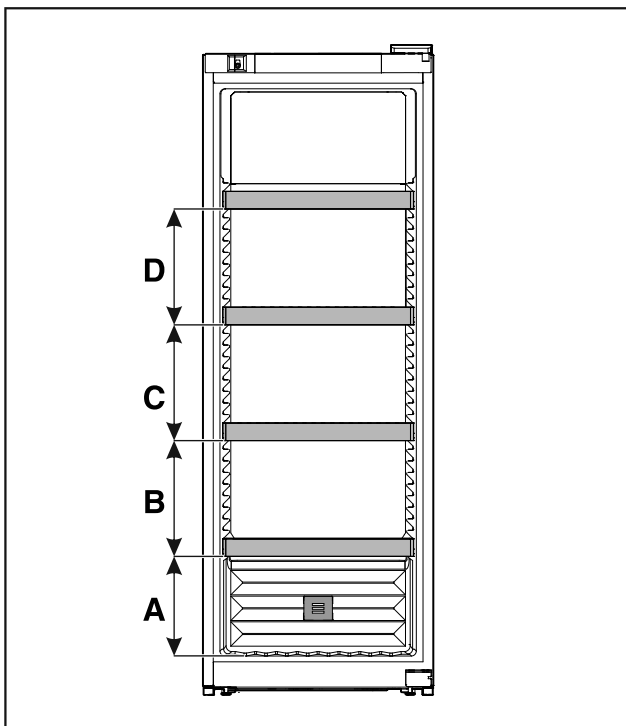

Fig. 10 Grid shelf spacing

WPbl 50.. / WSbl 50..	
A	260 mm
B	300 mm
C	300 mm
D	300 mm

5.2.4 WPbli 50.. / WSbli 50..

The maximum number of bottles is only possible with the specified spacings.

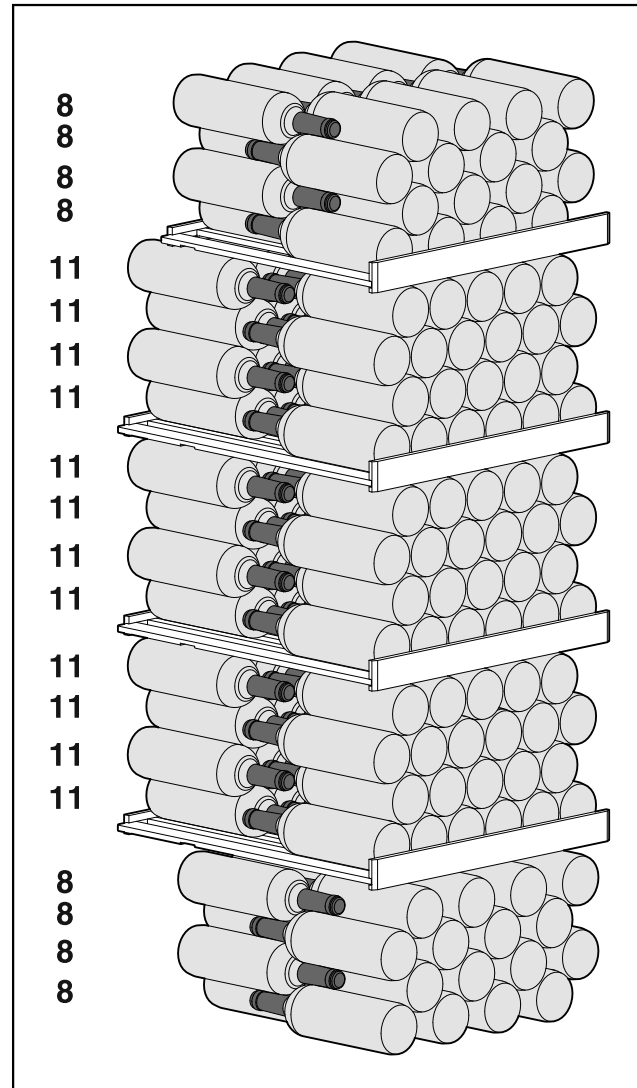

Fig. 11 Total 196 bottles

Storage

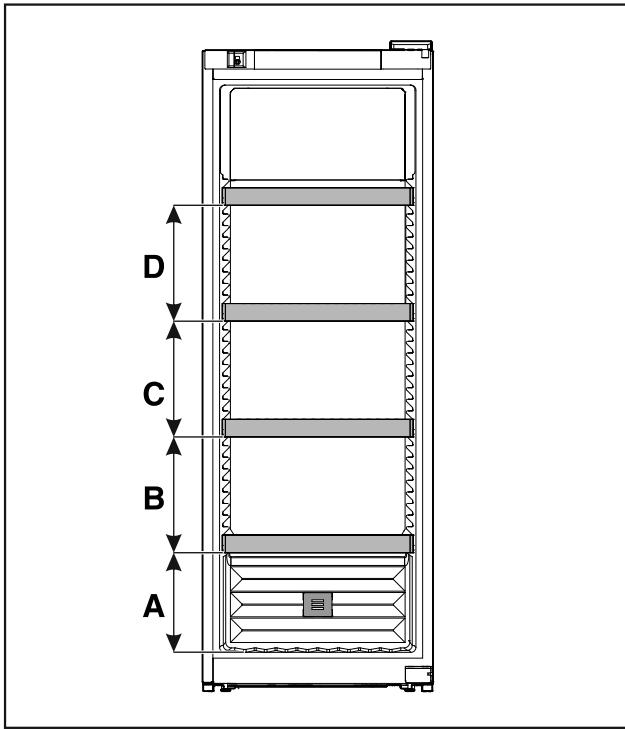

Fig. 12 Grid shelf spacing

	WPbli 50.. / WSbli 50..
A	260 mm
B	300 mm
C	300 mm
D	300 mm

WPbli 52.. / WSbli 52..

The maximum number of bottles is only possible with the specified spacings.

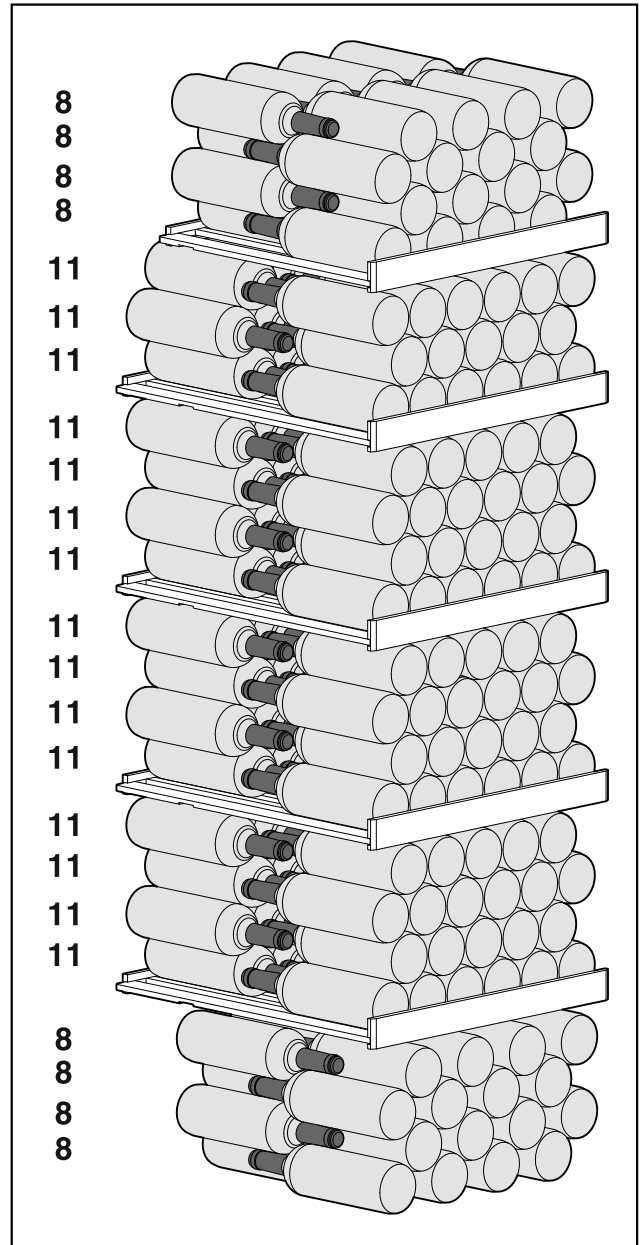

Fig. 13 Total 229 bottles

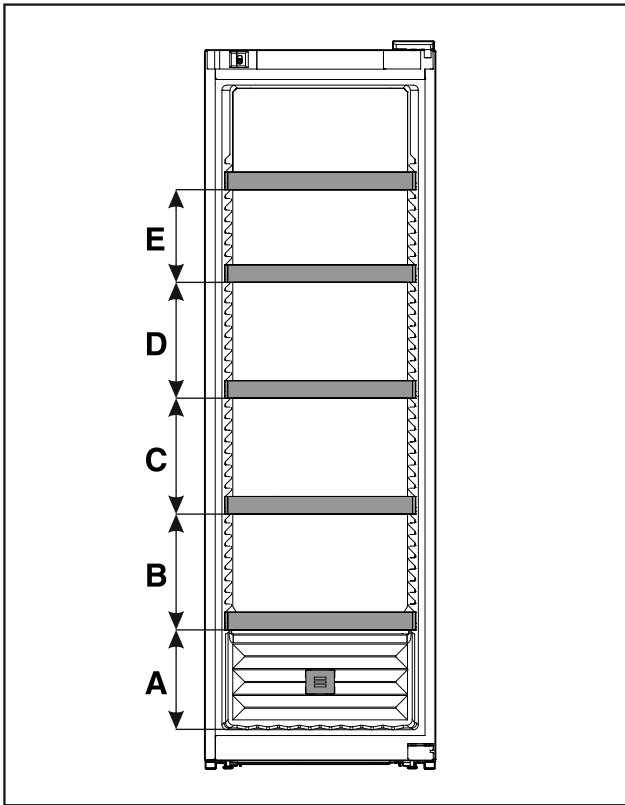

Fig. 14 Grid shelf spacing

	WPbli 52.. / WSbli 52..
A	260 mm
B	300 mm
C	300 mm
D	300 mm
E	240 mm

WSbli 77..

The maximum number of bottles is only possible with the specified spacings.

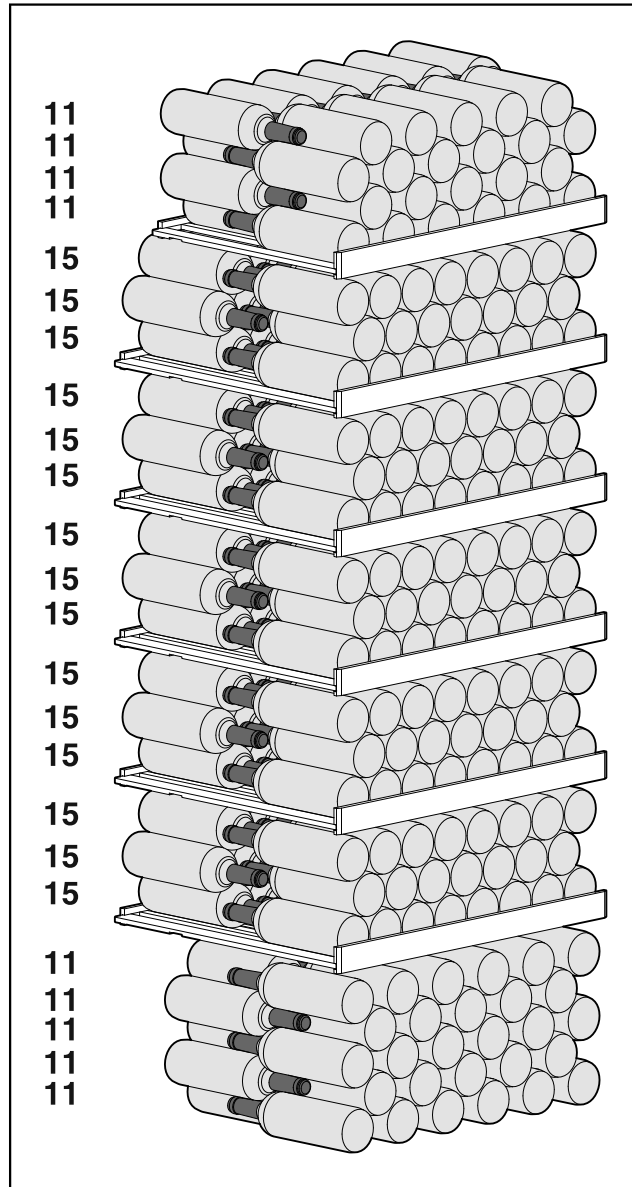

Fig. 15 Total 324 bottles

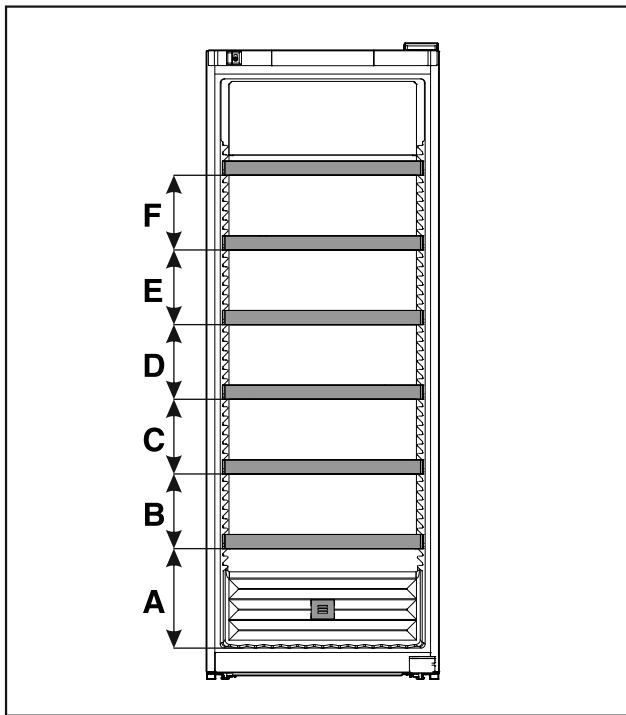

Fig. 16 Grid shelf spacing

	WSbli 77..
A	320 mm
B	240 mm
C	240 mm
D	240 mm
E	240 mm
F	240 mm

6 Saving energy

- Pay attention to good ventilation. Do not cover ventilation holes or grids.
- Always keep the fan air slits clear.
- Do not place the appliance in direct sunlight or near radiators or similar sources of heat.
- If the appliance is placed directly next to an oven, the energy consumption may increase slightly. This is dependent on the service life and usage intensity of the oven.
- Energy consumption depends on the installation conditions, e.g. the ambient temperature (see 1.4 Appliance range of use) . A warmer ambient temperature can increase the energy consumption.
- Open the appliance for as short a time as possible.
- The lower the temperature is set the higher the energy consumption.

Dust deposits increase energy consumption:

- For refrigerators with heat exchangers dust the metal grid on the back of the appliance once a year.



7 Controls

7.1 Control and display elements

The display provides a quick overview of the current appliance status, the temperature setting, the status of functions and settings as well as alarm and error messages.

It is operated using the navigation arrows and confirmation symbol.

Functions can be activated or deactivated and setting values can be changed.

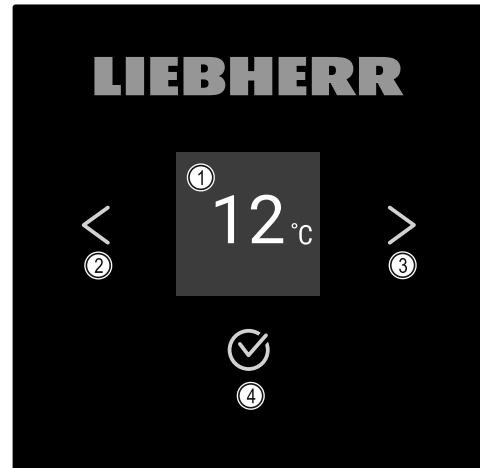

Fig. 17 Display

- (1) Status display
- (2) Backwards navigation arrow
- (3) Forward navigation arrow
- (4) Confirm arrow

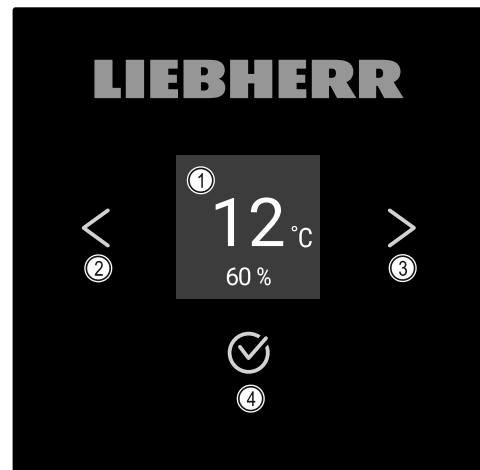

Fig. 18 Display with HumidityControl

- (1) Status display
- (2) Backwards navigation arrow
- (3) Forward navigation arrow
- (4) Confirm arrow

Status display



Fig. 19 Status display with temperature*



Fig. 20 Status display*

(1) Temperature (2) Humidity

The status display shows the temperature and is the home display. You navigate from here to the other functions and settings. The status display may show a range of display symbols.

Display symbols

Display symbols provide information about the status of the appliance.

Symbol	Appliance status
	Standby Appliance is switched off.
	Flashing standby symbol Appliance is starting up.
	Flashing temperature Target temperature not yet reached. Appliance cooling to temperature set.
	Temperature display
	D in the display Appliance is in DemoMode.
	Flashing symbol A fault is still active.
	Error symbol Appliance is in error state.
	White bar at the bottom Submenu
	White background Default, active setting or active value

Symbol	Appliance status
	Increasing bar Press button for 3 seconds to activate setting.
	Decreasing bar Press button for 3 seconds to deactivate setting.

Status display symbols

Acoustic signals

A signal sounds in the following cases:

- If a function or a value is confirmed.
- If a function or a value can either not be activated or not deactivated.
- As soon as an error occurs.
- If there is an alarm message.

The alarms can be switched on and off in the customer menu.

7.2 Appliance functions

7.2.1 Notes on the appliance functions

The appliance functions are set at the factory so that your appliance is fully functional.

Before you alter, activate or deactivate the device functions, make sure that the following requirements are met:

- You have read and understood the descriptions of how the display works. (see 3 Functionality of the Touch display)
- You have familiarised yourself with the operating and display elements of your appliance. (see 7.1 Control and display elements)

7.2.2 Switching appliance on and off



Using this setting the entire appliance can be switched on and off.

Switching on appliance

Without activated DemoMode:

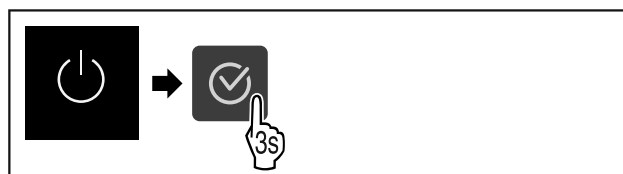

Fig. 21

► Carry out action steps according to the illustration.

With activated DemoMode:

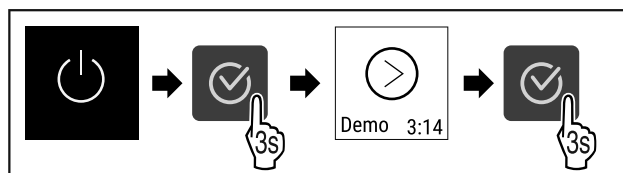

Fig. 22

► Carry out action steps according to the illustration.

Note

Deactivate DemoMode before countdown finishes.

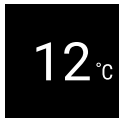

Fig. 23 *

► The temperature appears in the display.

Switching off appliance

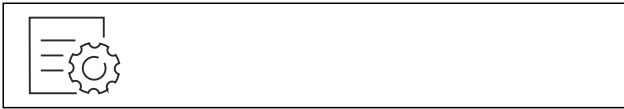

Fig. 24

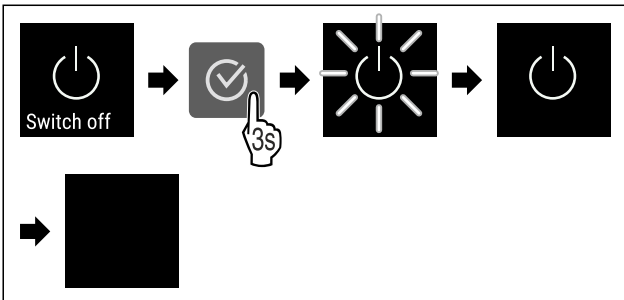

Fig. 25

- Carry out action steps according to the illustration.
- Standby symbol is shown in the display.
- Display switches off after approximately 10 minutes.

7.2.3 WiFi

Use this function to connect your appliance to WiFi. You can then operate it via the SmartDevice app on a mobile device. You can also use this function to disconnect or reset the WiFi connection.

To connect your device to WiFi, you need the SmartDeviceBox.*

More information on the SmartDevice: (see 1.3 SmartDevice)

Note

The SmartDevice function is not available in the following countries: Russia, Belarus, Kazakhstan.

You cannot use the SmartDeviceBox.*

Establishing the WiFi connection for the first time

Make sure that the following requirements are fulfilled:

- You have purchased and inserted a SmartDeviceBox. (see 1.3 SmartDevice) *
- You have installed the SmartDevice app (see apps.home.liebherr.com).
- Registration in the SmartDevice app is completed.

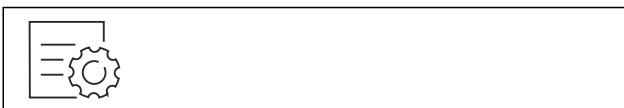

Fig. 26

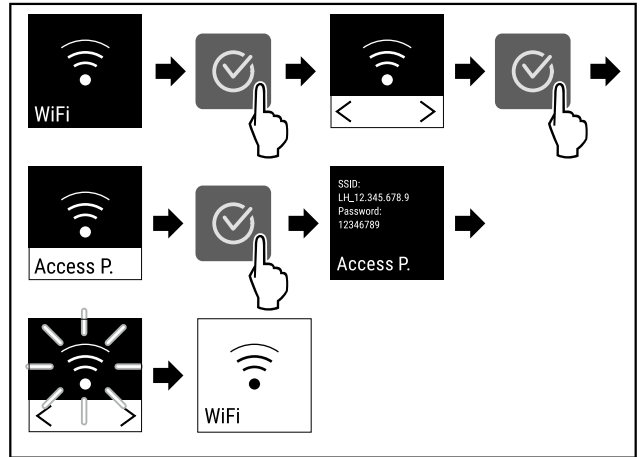

Fig. 27

- Carry out action steps according to the illustration.
- Connection is established.

Disconnecting from the WiFi

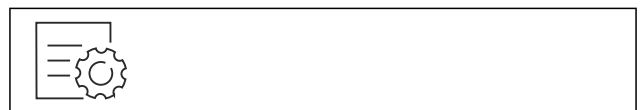

Fig. 28

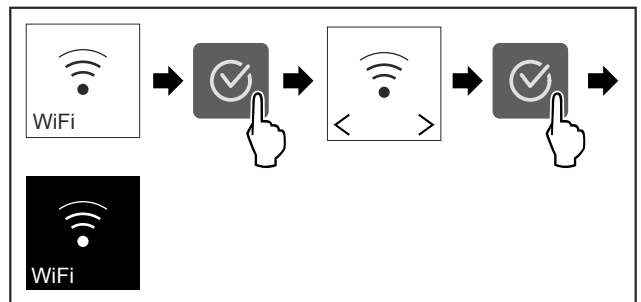

Fig. 29

- Carry out action steps according to the illustration.
- There is no connection.

Resetting the WiFi connection



Fig. 30

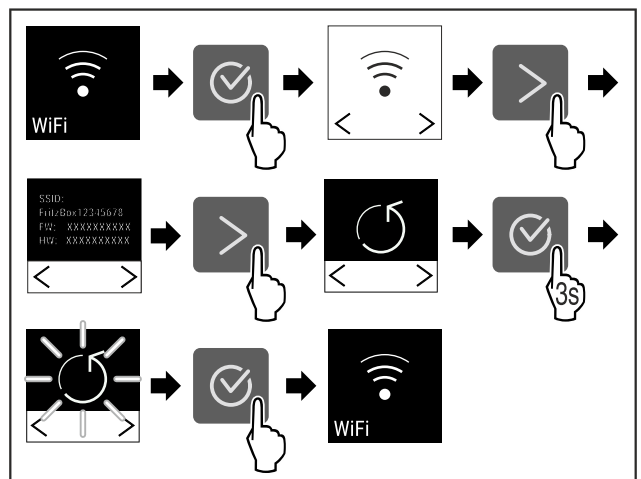

Fig. 31

- Carry out action steps according to the illustration.

- ▶ WiFi connection and other WiFi settings are reset to factory settings.

Showing information about the WiFi connection

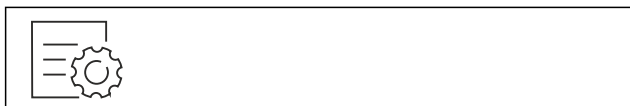

Fig. 32

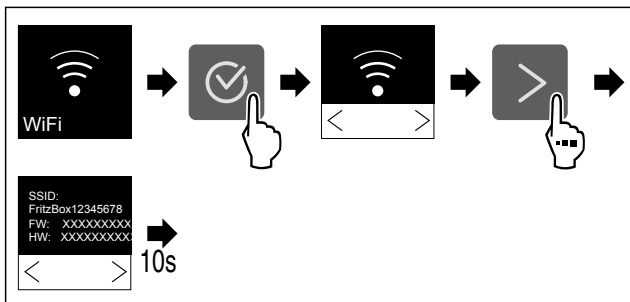

Fig. 33

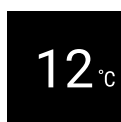

Fig. 34 Status display

- ▶ Carry out action steps according to the illustration.

7.2.4 Temperature



The temperature depends on the following factors:

- How often the door is opened
- How long the door is open for
- The room temperature of the installation site
- The type, temperature and amount of refrigerated items

Setting temperature

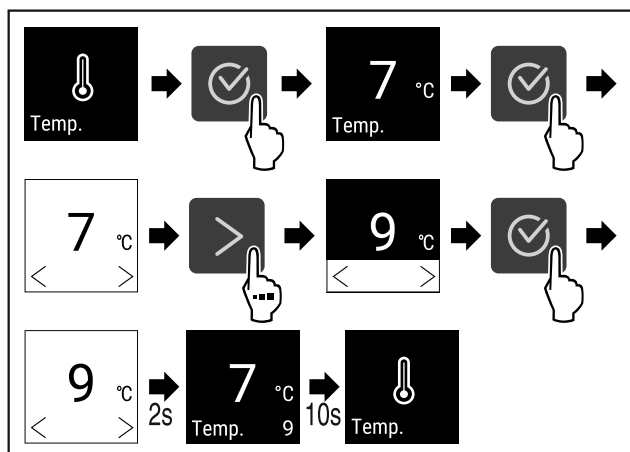

Fig. 35 Changing temperature from 7 °C to 9 °C

- ▶ Carry out action steps according to the illustration.
- ▶ Temperature is set.

7.2.5 Temperature unit



Use this function to set the temperature unit. You can set degrees Celsius or degrees Fahrenheit as the temperature unit.

Setting the temperature unit

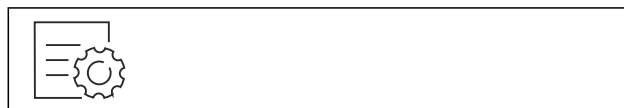

Fig. 36

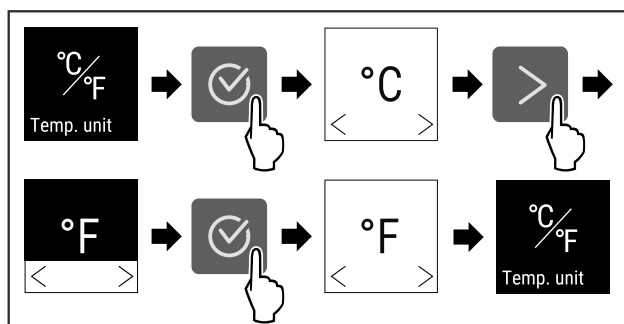

Fig. 37 Example illustration: Switch from degrees Celsius to degrees Fahrenheit.

- ▶ Carry out action steps according to the illustration.
- ▶ The temperature unit is set.

7.2.6 SabbathMode



You can use this function to activate or deactivate SabbathMode. If you activate this function, some electronic functions are switched off. As a result, your device meets the religious requirements for Jewish holidays such as Sabbath and complies with STAR-K Kosher certification.

Device status when SabbathMode is active
The status display shows SabbathMode permanently.
All functions on the display are locked except for the Deactivate SabbathMode function.
Active functions remain active.
The display remains bright when you close the door.
The interior lighting is deactivated.
Reminders are not implemented. The set time interval stops.
Reminders and warnings are not displayed.
There is no door alarm.
There is no temperature alarm.
After a power failure, the appliance returns to SabbathMode.

Device status

Note

This appliance has certification from the "Institute for Science and Halacha". (www.machonhalacha.co.il)

You can find a list of STAR-K-certified appliances at www.star-k.org/appliances.

Activating SabbathMode



Fig. 38

Controls

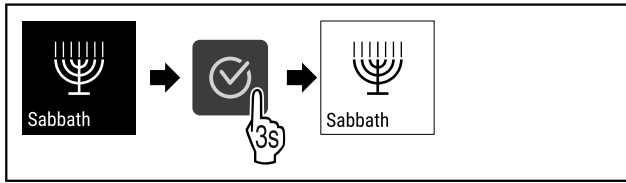

Fig. 39

- ▶ Carry out action steps according to the illustration.
- ▶ SabbathMode is activated.
- ▶ The status display shows SabbathMode permanently.

Deactivating SabbathMode

The SabbathMode is automatically deactivated after 80 hours. However, you can also deactivate SabbathMode manually at any time:

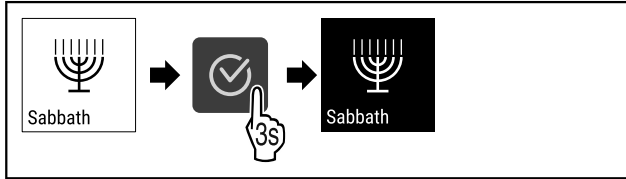

Fig. 40

- ▶ Carry out action steps according to the illustration.
- ▶ SabbathMode is deactivated.

7.2.7 HumiditySelect *

Use this function to set the humidity inside your appliance. Setting the humidity correctly will have a positive effect on the structure of the corks during long-term storage and prevent them from drying out.

Note

The frequency and duration for which the door is open influence the humidity in the appliance.

You can choose between two humidity settings:*

HumiditySelect function*	Temperature setting on the appliance*	Application/energy consumption*
Standard (preset)	10-12 °C	average humidity in the environment between 50-80% low energy consumption of the appliance
High	10-12 °C	average humidity in the environment < 50% energy consumption of the appliance increases

Increasing the humidity in the appliance



Fig. 41

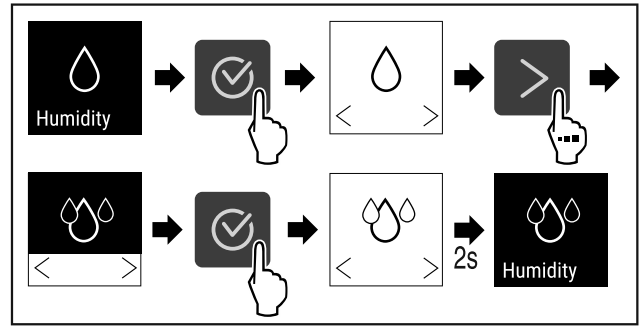

Fig. 42 *

- ▶ Carry out action steps according to the illustration.
- ▶ Humidity in the appliance increases.

Setting the humidity in the appliance to standard

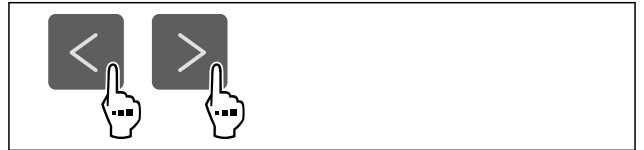

Fig. 43

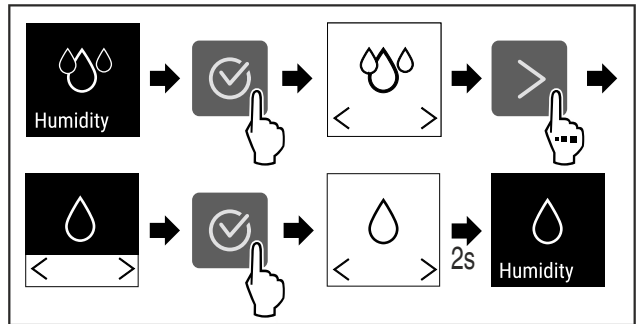

Fig. 44 *

- ▶ Carry out action steps according to the illustration.
- ▶ Humidity in the appliance decreases.

7.2.8 HumidityControl *

Use this function to set the humidity inside your appliance. Your appliance is equipped with a humidity sensor. Setting the humidity correctly will have a positive effect on the structure of the corks during long-term storage and prevent them from drying out.

You can set the humidity between 50% and 80% in five percent increments. If you change the humidity, it will adjust to the changed value within a few days to weeks. Humidity control works best at ambient temperatures of 19 °C to 25 °C.

Observe the following for the humidity in the appliance:

- Notes on storing wine
- The humidity in the appliance depends on the frequency and duration of door openings, ambient temperature and humidity, load, and the appliance setting.
- Fluctuations caused by physical influences affect the humidity measurement in the appliance.
- The display shows changes in humidity in the appliance with a time delay.
- The display shows a humidity value averaged over 2 hours.

Note

If you operate your appliance in a very dry and cold environment (humidity < 30% and ambient temperature < 16 °C), Liebherr recommends you acquire the water box from the accessories range.

Accessories can be purchased from the Liebherr-Hausgeräte store at home.liebherr.com/shop/de/deu/zubehor.html.

Changing the humidity in the appliance

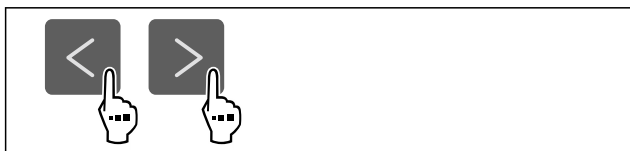

Fig. 45

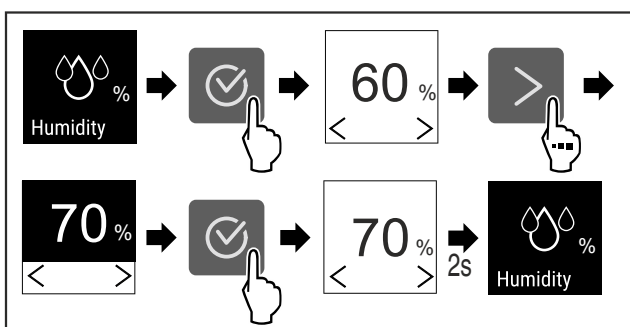

Fig. 46

- ▶ Carry out action steps according to the illustration.
- ▶ Humidity in the appliance changes to the selected value.

7.2.9 Lighting intensity *

This setting allows the interior brightness to be adjusted incrementally.

The following brightness values can be set:

- Off
- 20%
- 40%
- 60%
- 80%
- 100% (default)

Setting lighting intensity

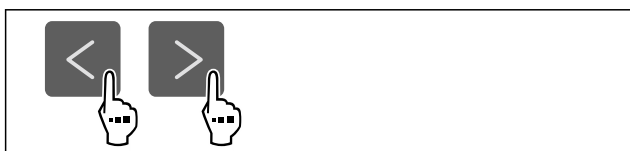

Fig. 47

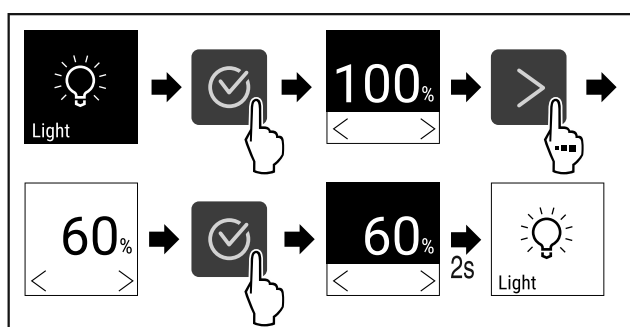

Fig. 48

- ▶ Carry out action steps according to the illustration.
- ▶ The lighting intensity increases or decreases accordingly.

7.2.10 Display brightness

Use this function to set the display brightness in stages.

You can select the following brightness levels:

- 20 %
- 40 %
- 60 %
- 80 %
- 100 % (pre-setting)

Setting the brightness

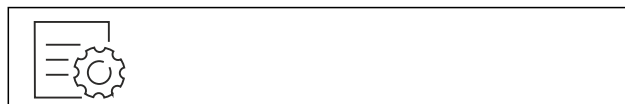

Fig. 49

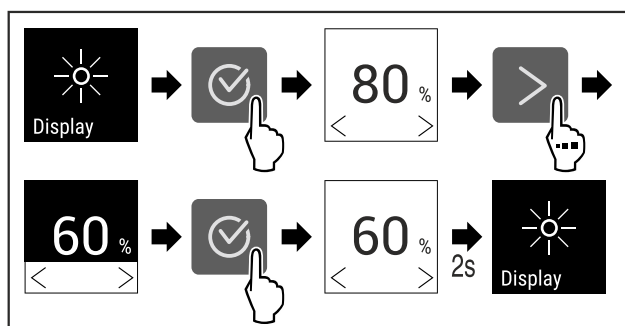

Fig. 50 Example illustration: Switch from 80 % to 60 %.

- ▶ Carry out action steps according to the illustration.
- ▶ The brightness is set.

7.2.11 Door alarm

Use this function to activate or deactivate the door alarm. The door alarm sounds if the door is open for too long. The door alarm is activated on delivery. You can set how long the door may be open before the door alarm sounds.

The following values can be set:

- 1 minute
- 2 minutes
- 3 minutes
- Off

Setting the door alarm



Fig. 51

Controls

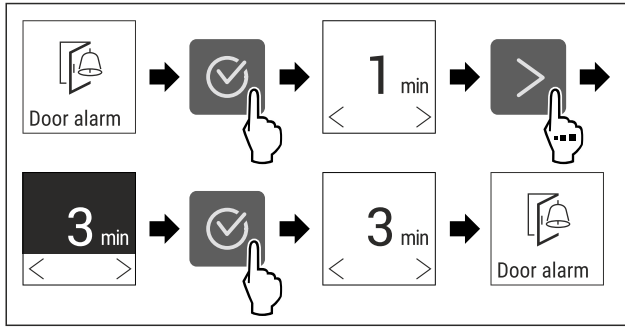

Fig. 52 Example illustration: Change door alarm from 1 minute to 3 minutes.

- ▶ Carry out action steps according to the illustration.
- ▷ The door alarm is set.

Deactivating the door alarm



Fig. 54

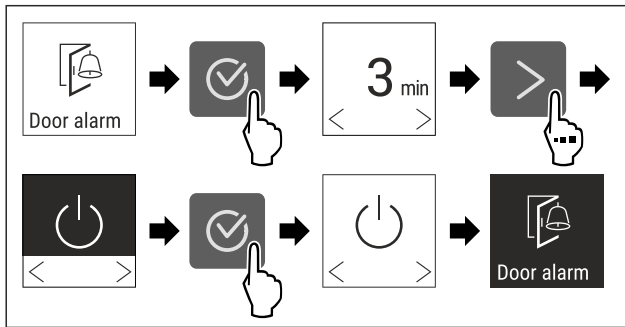

Fig. 55

- ▶ Carry out action steps according to the illustration.
- ▷ The door alarm is deactivated.

7.2.12 Alarm Sound



This function enables all alarm sounds, such as door alarm, to be switched on and off.

Activating Alarm Sound



Fig. 56

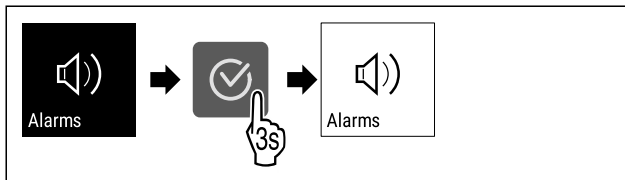

Fig. 57

- ▶ Carry out action steps according to the illustration.
- ▷ Alarm Sound is activated.

Deactivating Alarm Sound



Fig. 58

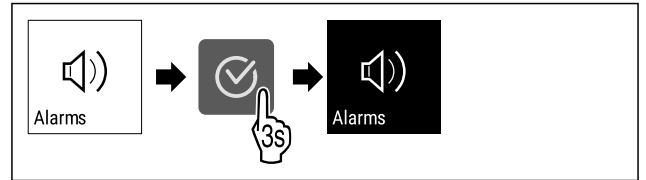

Fig. 59

- ▶ Carry out action steps according to the illustration.
- ▷ Alarm Sound is deactivated.

7.2.13 Key Sound



This function makes it possible to switch all confirmation sounds and the Startsound on and off.

Activating Key Sound



Fig. 60

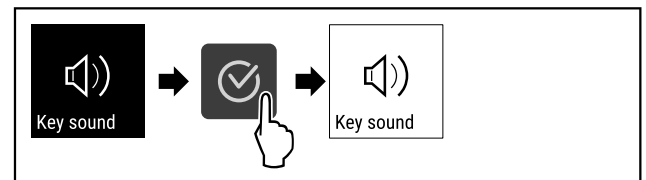

Fig. 61

- ▶ Carry out action steps according to the illustration.
- ▷ Key Sound is activated.

Deactivating Key Sound



Fig. 62

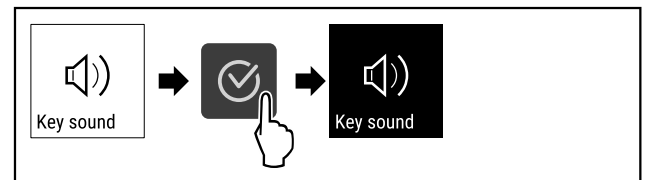

Fig. 63

- ▶ Carry out action steps according to the illustration.
- ▷ Key Sound is deactivated.

7.2.14 Display lock



This setting avoids accidental operation of the appliance.

Application:

- Prevent settings and functions being changed unintentionally.
- Prevent appliance being switched off unintentionally.
- Prevent temperature being set unintentionally.

Activating display lock



Fig. 64

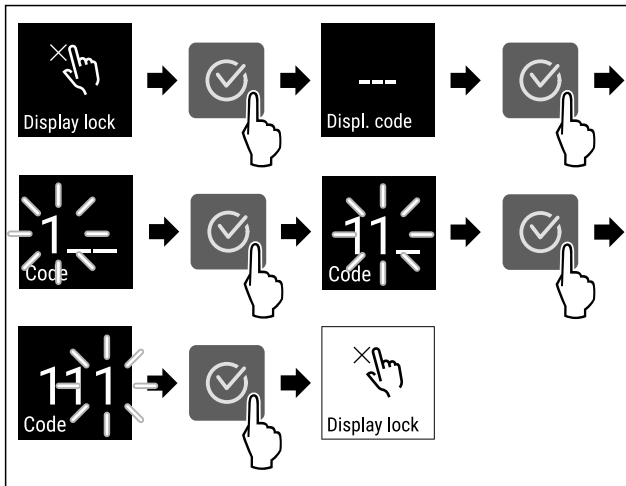

Fig. 65 Example uses the preset display code **111**.

- ▶ Carry out action steps according to the illustration.
- ▶ The display lock is activated.
- ▶ The status display appears.

Unlocking the display for a short time

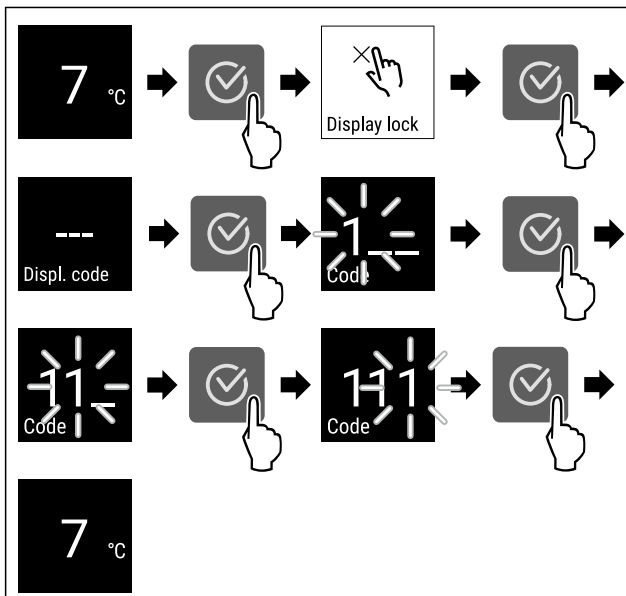

Fig. 66 *

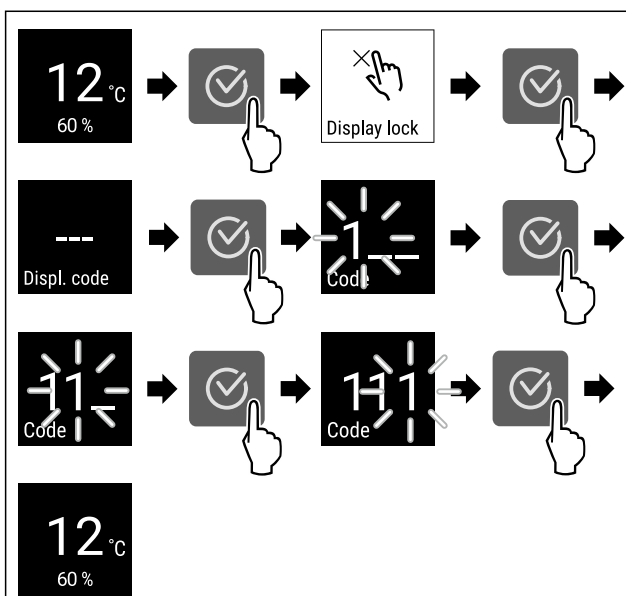

Fig. 67 *

- ▶ Carry out action steps according to the illustration.
- ▶ The display lock is deactivated.
- ▶ The status display appears.

7.2.15 Display PIN



Use this function to change the display PIN. The display PIN is set to 1 1 1 on delivery. If you have forgotten the display PIN, you can reset the display PIN by resetting the appliance to the factory settings. (see 7.2.21 Resetting to factory settings)

Changing the display PIN



Fig. 68

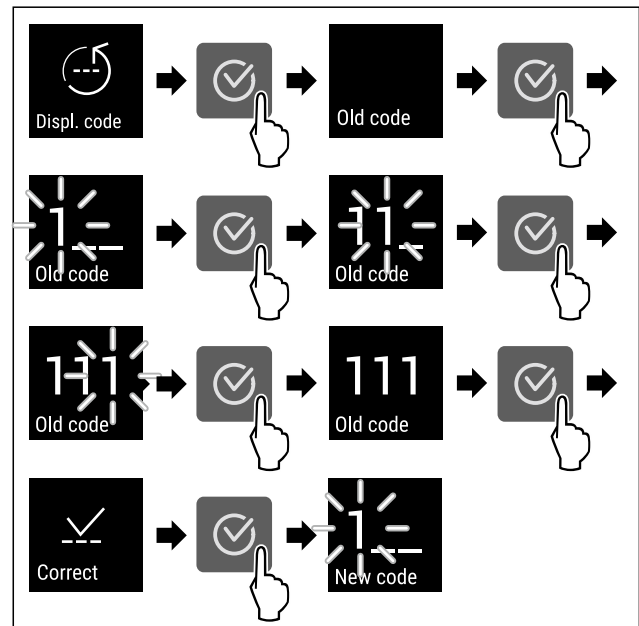

Fig. 69 Example illustration: Change display PIN from factory setting 1 1 1 to 2 3 4

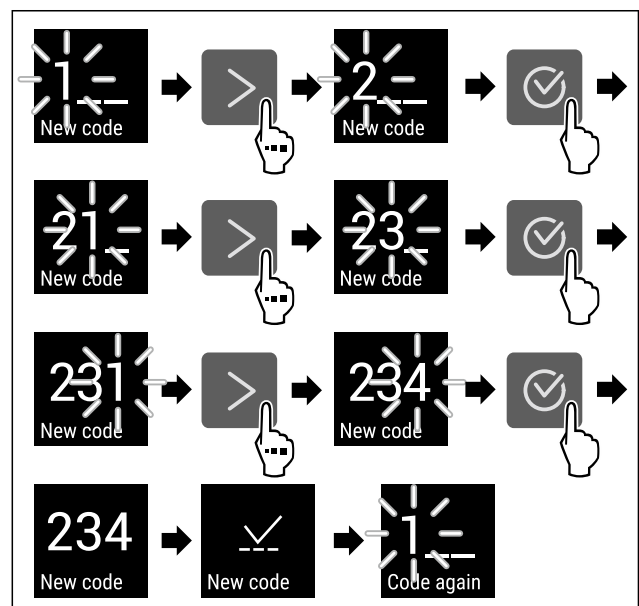

Fig. 69 Example illustration: Change display PIN from factory setting 1 1 1 to 2 3 4

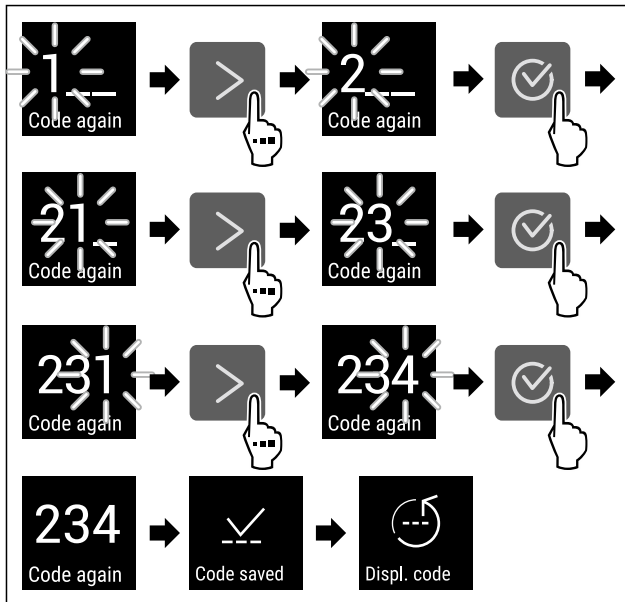

Fig. 69 Example illustration: Change display PIN from factory setting 1 1 1 to 2 3 4

- ▶ Carry out action steps according to the illustration.
- ▷ Display PIN is changed.



7.2.16 Language

This setting allows the display language to be set.

Setting language



Fig. 70

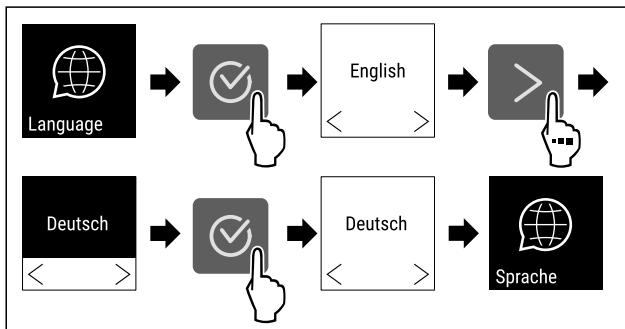

Fig. 71

- ▶ Carry out action steps according to the illustration.
- ▷ The selected language is set.



7.2.17 Device information

Use this function to indicate the model name, index, serial number and service number of your device. You will need the device information when you contact customer service. (see 10.4 Customer Service)

This function also opens the Advanced menu. (see 3 Functionality of the Touch display)

Indicating the device information



Fig. 72



Fig. 73

- ▶ Carry out action steps according to the illustration.
- ▷ Display indicates device information.



7.2.18 Software

Use this function to indicate the software version of your device.

Indicating the software version



Fig. 74



Fig. 75

- ▶ Carry out action steps according to the illustration.
- ▷ Display indicates software version.



7.2.19 Reminder

This function allows you to activate or deactivate the reminder to change the FreshAir activated charcoal filter.

Deactivating the reminder

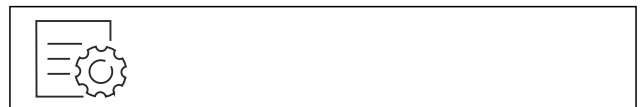

Fig. 76

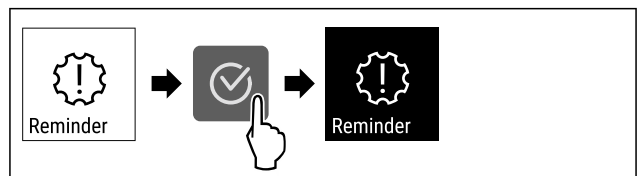

Fig. 77

- ▶ Carry out steps according to the illustration.
- ▷ Reminder is deactivated.

Activating the reminder



Fig. 78

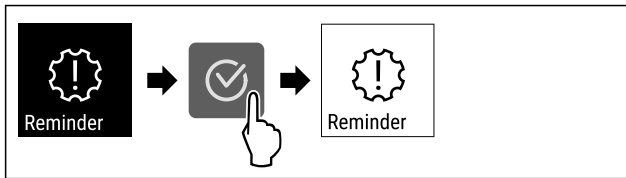

Fig. 79

- ▶ Carry out steps according to the illustration.
- ▶ Reminder is activated.

7.2.20 Demo mode



Demo mode is a special feature for dealers who want to demonstrate appliance features. If you activate demo mode, all refrigeration functions are deactivated.

If you switch on your appliance and a “D” appears on the status display, demo mode is already activated.

If you activate and then deactivate demo mode, the appliance will be reset to factory defaults. (see 7.2.21 Resetting to factory settings)

Activating demo mode

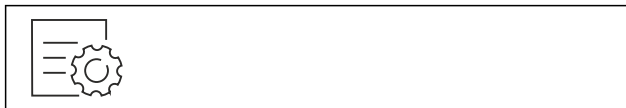

Fig. 80

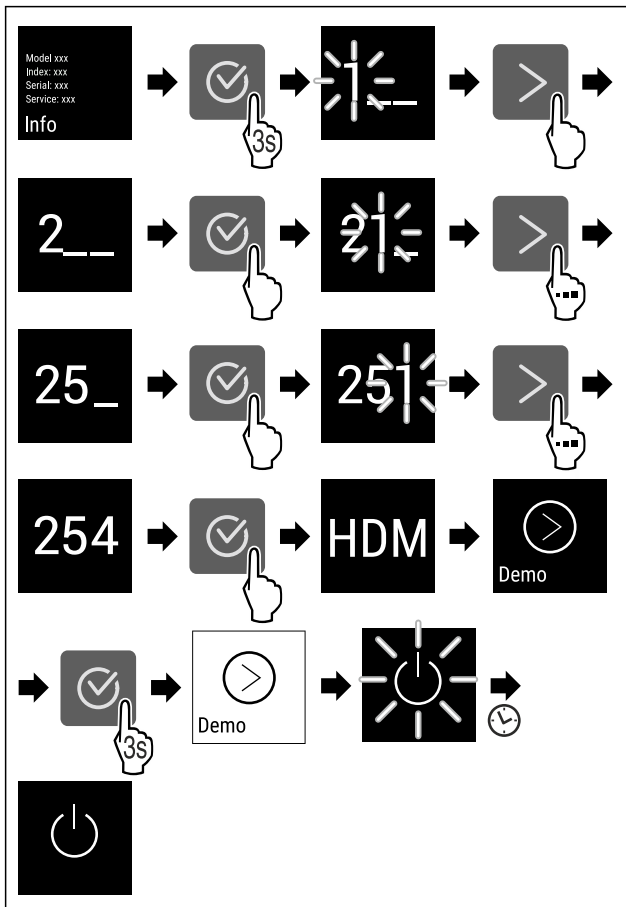

Fig. 81

- ▶ Carry out action steps according to the illustration.
- ▶ Demo mode is activated.
- ▶ Appliance is switched off.
- ▶ Switch on the appliance. (see 4.1 Switching on appliance (first use))
- ▶ “D” appears in the status display.

Deactivating demo mode



Fig. 82

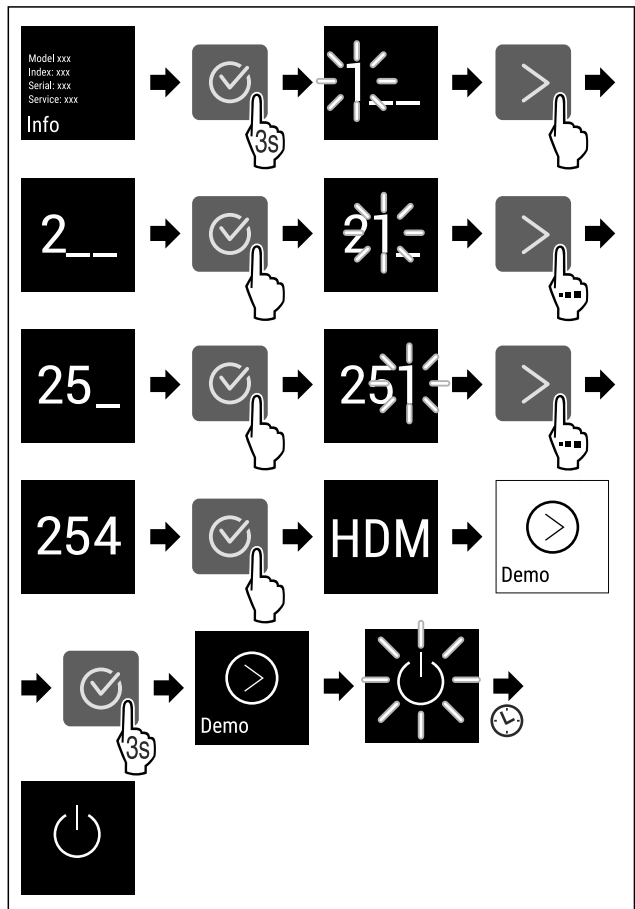

Fig. 83

- ▶ Carry out action steps according to the illustration.
- ▶ Demo mode is deactivated.
- ▶ Appliance is switched off.
- ▶ Switch on the appliance. (see 4.1 Switching on appliance (first use))
- ▶ Appliance is reset to factory settings.

7.2.21 Resetting to factory settings



Use this function to reset all settings to factory defaults. All settings you have made so far are reset to their original settings.

Performing a reset

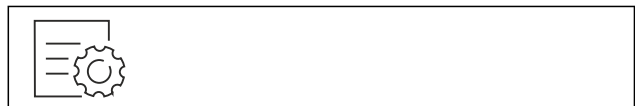

Fig. 84

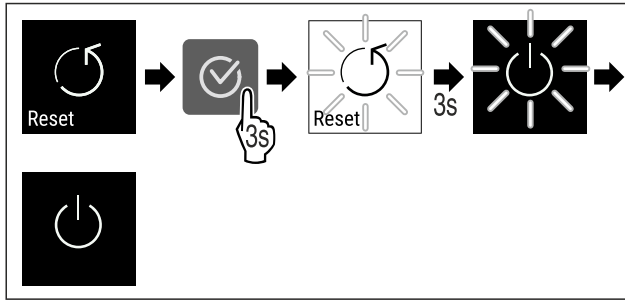

Fig. 85









► Carry out action steps according to the illustration.

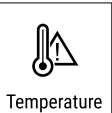

- ▷ Device is reset.
- ▷ Device is switched off.
- ▷ Restart the device. (see 4.1 Switching on appliance (first use))

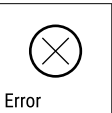
7.3 Messages

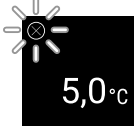
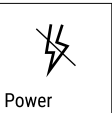
7.3.1 Warnings



Warnings are issued by means of an audio signal and visually via a symbol on the display. The signal gets louder until the warning is acknowledged.

Message	Cause	Remedy
 Door open Door open	This message appears if the door is open for too long.	Close the door. Press the confirmation button. Alarm is ended. Note You can set how long it takes for this message to appear (see 7.2.11 Door alarm). 
 Temperature Temperature alarm	This message appears if the temperature does not match the set temperature. Reasons for the differences in temperature can be: - Warm items for refrigeration have been placed inside. - Too much warm room air flowed in when rearranging and removing refrigerated products. The power was cut off for a prolonged period.	Press the confirmation button. Warmest temperature is displayed. Press the confirmation button. The current temperature flashes and the display alternates with the temperature alarm symbol until the set temperature is reached. Check the quality of the refrigerated goods.  
 Error Error	The appliance is defective, there is an appliance fault or a component of the appliance is faulty.	Transfer refrigerated goods. Press the confirmation button. Error code is displayed. Press the confirmation button. If present, another error code is indicated. or Status screen with flashing error symbol is displayed Pressing the navigation buttons indicates error code(s) again. Note the error code(s) and contact customer service.   
 Power Power failure	The message appears after an interruption in the power supply if the temperature is above the alarm limit when the power returns.	Press the confirmation button. The warmest temperature is displayed. Press the confirmation button. Alarm is cancelled and current temperature is indicated. Check the quality of the refrigerated goods.  

Message	Cause	Remedy
 WiFi error WLAN error	WLAN connection is interrupted.	Check the connection. Press the confirmation button. Alarm is ended.
 WWW error WLAN WWW error	The message appears if there is no Internet connection via WLAN.	Check the connection. Press the confirmation button. Alarm is ended.

7.3.2 Reminder

Reminders appear when you are being asked to do something. They are issued by means of an audio signal and visually via a symbol on the display. Acknowledge the message by pressing the confirmation button.

Message	Cause	Remedy
 FreshAir ReplaceFreshAir activated charcoal filter	The message appears every 6 months.	 ReplaceFreshAir activated charcoal filter, Reminder is closed.
 Humidity *	This message appears if humidity falls below 50%.*	 Fill water tray.* Reminder is closed.*

8 Features

8.1 Safety lock

The lock in the appliance door is equipped with a safety mechanism.

8.1.1 Locking appliance

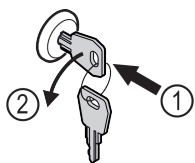

Fig. 86 Example illustration

- ▶ Insert key.
- ▶ Turn key anticlockwise by 90°.
- ▶ The appliance is locked.

8.1.2 Unlocking appliance

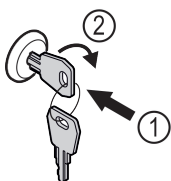

Fig. 87 Example illustration

- ▶ Insert key Fig. 87 (1).

- ▶ Turn key clockwise by 90° Fig. 87 (2).
- ▶ The appliance is unlocked.

8.2 Labels

Description labels as accessories can be purchased from your specialist dealer. You can use these to note the types of wine that are stored in the respective compartment.

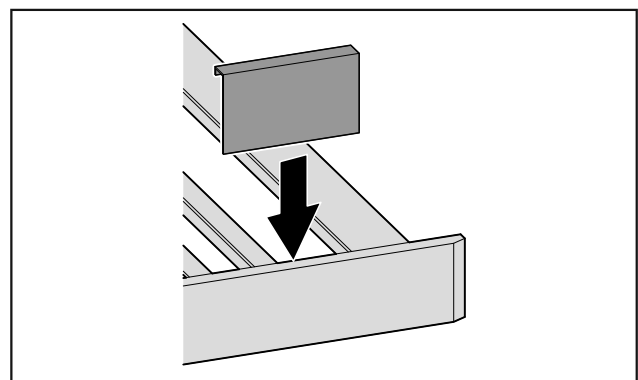

Fig. 88

- ▶ Attach the label from above.

9 Maintenance

9.1 Air exchange through the FreshAir activated charcoal filter

Wine is constantly developing according to its ambient conditions, so air quality is essential for preservation.

The FreshAir activated charcoal filter guarantees optimal air quality.

- ❑ Change the activated charcoal filter every 6 months.
- ❑ Dispose of the activated charcoal filter with regular household waste.

Note

FreshAir activated charcoal filters can be purchased from the Liebherr-Hausgeräte store at home.liebherr.com/shop/de/deu/zubehor.html.

9.1.1 Replacing the FreshAir activated charcoal filter

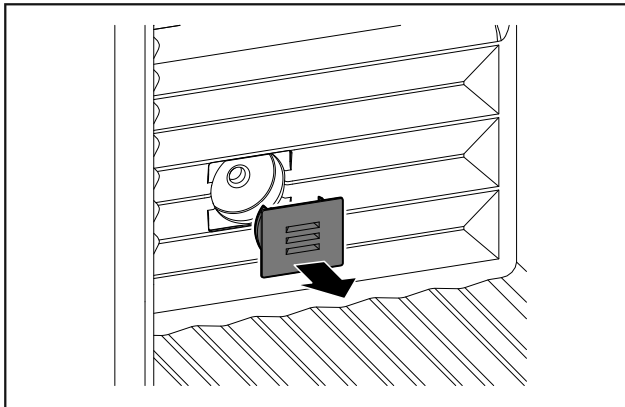

Fig. 89

- ▶ Pull off the cover.

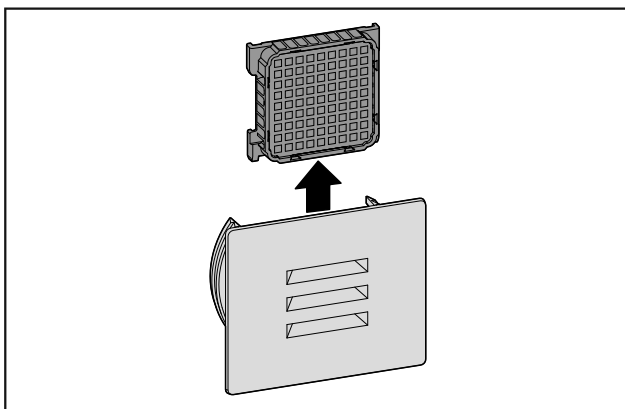

Fig. 90

- ▶ Pull out the filter.

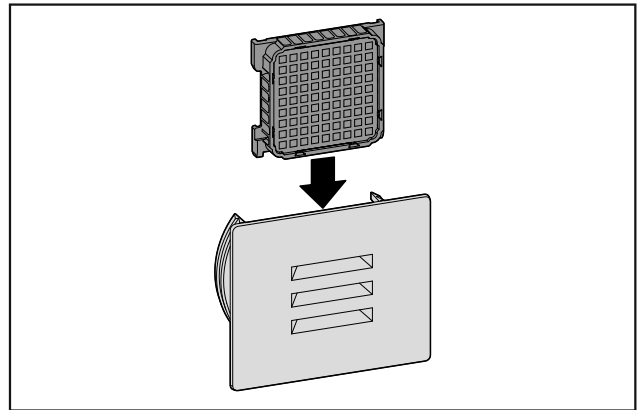

Fig. 91

- ▶ Insert the new filter.

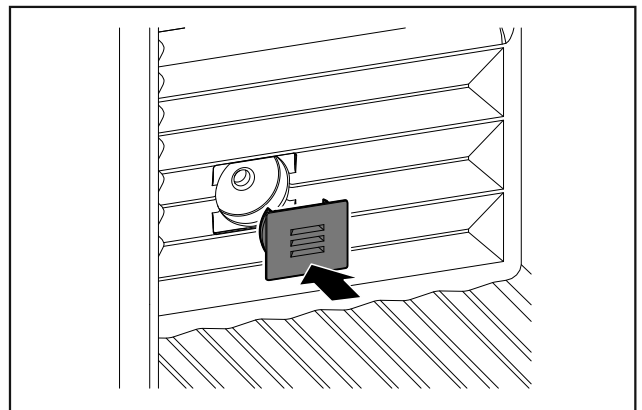

Fig. 92

- ▶ Set the cover back in place.

9.2 Cleaning the appliance

9.2.1 Ready



WARNING

Danger of electric shock!

- ▶ Remove the refrigerator connector or interrupt the power supply.



WARNING

Risk of fire

- ▶ Do not damage the refrigeration circuit.

- ▶ Empty the appliance.
- ▶ Remove mains connector.

9.2.2 Clean the housing

NOTICE

Improper cleaning!

Damage to the appliance.

- ▶ Only use soft cleaning cloths and ph-neutral all-purpose cleaners.
- ▶ Do not use abrasive sponges or steel wool which may cause scratches.
- ▶ Do not use any sharp or abrasive cleaning agents, nor any that contain sand, chloride or acid.



WARNING

Risk of injury and damage as a result of hot steam!
Hot steam can lead to burns and can damage the surfaces.
▶ Do not use any steam cleaners!

- ▶ Wipe the housing down with soft, clean cloth. If very dirty, use lukewarm water with a neutral cleaner. Glass surfaces can also be cleaned with glass cleaner.

9.2.3 Cleaning the interior

NOTICE

Improper cleaning!
Damage to the appliance.

- ▶ Only use soft cleaning cloths and ph-neutral all-purpose cleaners.
- ▶ Do not use abrasive sponges or steel wool which may cause scratches.
- ▶ Do not use any sharp or abrasive cleaning agents, nor any that contain sand, chloride or acid.

- ▶ Plastic surfaces: clean by hand with a soft clean cloth, lukewarm water and a little detergent.
- ▶ Metal surfaces: clean by hand with a soft clean cloth, lukewarm water and a little detergent.
- ▶ Drain hole: remove deposits using a thin item (for example a cotton bud).

9.2.4 Cleaning the equipment

NOTICE

Improper cleaning!
Damage to the appliance.

- ▶ Only use soft cleaning cloths and ph-neutral all-purpose cleaners.
- ▶ Do not use abrasive sponges or steel wool which may cause scratches.
- ▶ Do not use any sharp or abrasive cleaning agents, nor any that contain sand, chloride or acid.

Cleaning with a damp, lint-free cloth:

- Bottle shelf
- ▶ Clean the equipment.

9.2.5 After cleaning

- ▶ Wipe the appliance and the components dry.
- ▶ Connect and switch on the appliance.
- ▶ Repeat cleaning regularly.

10 Customer help

10.1 Technical specifications

Maximum loading weight for the bottle rack	
Bottle shelf	60 kg
Bottle rack with telescopic rails	25 kg

Lighting	
Class ¹	Light source
This product contains one or more energy efficiency class G light sources.	LED

¹ The appliance may contain light sources with different energy efficiency classes. The lowest energy efficiency class is indicated.

For appliances with a WiFi connection:*

Frequency specification*	
Frequency band	2.4 GHz
Maximum radiated power	< 100 mW
Purpose of the wireless equipment	Integration in the local WiFi network for data communication

10.2 Operating noises

The appliance makes different noises when it is on.

- At **higher temperatures** the appliance uses less energy but works for longer. It is **quieter**.
- At **lower temperatures** the food is cooled faster. It is **louder**.

Examples:

- Functions on (see 7.2 Appliance functions)
- Fan running
- Food recently added
- High ambient temperature
- Door open for a while

Noise	Possible cause	Type of noise
Bubbling and splashing	Coolant flowing into the cooling circuit.	Normal operating noise
Hissing	Coolant sprays into the cooling circuit.	Normal operating noise
Humming	The appliance is cooling. The volume depends on the cooling output.	Normal operating noise
Humming and rustling	The fan is running.	Normal operating noise
Clicking	Components are switched on and off.	Normal switching noise
Rattling or humming	Valves or flaps are working.	Normal switching noise

Noise	Possible cause	Type of noise	Lifting
Vibration	Improper setup	Defective noise	Level the appliance using the adjustable feet.

Noise	Possible cause	Type of noise	Lifting
Rattling	Components, items inside the appliance	Defective noise	Secure components. Leave enough space between the items.

10.3 Technical fault

Your appliance is designed and built to ensure it works reliably and has a long service life. In the unlikely event that a fault occurs during operation, please check whether it is due to an operating error. If so, you will be charged for the callout and repair costs even if it falls within the warranty period.

You can fix the following faults yourself.

10.3.1 Appliance function

Defect	Cause	Remedy
The appliance is not working.	→ The appliance is not switched on.	▶ Switch the appliance on.
	→ The power plug is not properly plugged into the socket.	▶ Check the power plug.
	→ There is something wrong with the power outlet fuse.	▶ Check the fuse.
	→ Power cut	▶ Keep the appliance closed.
	→ The IEC socket is not plugged into the appliance correctly.	▶ Check the IEC socket.
Temperature is not cold enough.	→ The appliance door is not closed properly.	▶ Close the appliance door.
	→ The ambient temperature is too high.	▶ Problem solution: (see 1.4 Appliance range of use)
	→ The appliance was opened too many times or for too long.	▶ Wait to see if the required temperature corrects itself. If not, contact Customer Service. (see 10.4 Customer Service)
	→ The temperature is set incorrectly.	▶ Turn down the temperature and check after 24 hours.
	→ The appliance is too close to a heat source (oven, radiator, etc).	▶ Move the appliance or the heat source.
The door seal is defective or needs to be replaced for another reason.	→ The door seal can be replaced. It can be replaced without the need for special tools.	▶ Contact Customer Service. (see 10.4 Customer Service)
The appliance builds up too much ice or condensation.	→ The door seal may have slipped out of its groove.	▶ Check that the door seal is well fitted in the groove.
The exterior surfaces of the appliance are warm.*	→ The heat of the refrigeration circuit is used to avoid condensation.	▶ This is normal.

10.3.2 Features

Defect	Cause	Remedy
Mould on the wine bottles	→ Similar to other types of bearing, a slight layer of mould can form depending on the type of adhesive used for the label.	▶ Remove any adhesive residues.
The internal light does not come on.	→ The appliance is not switched on.	▶ Switch the appliance on.
	→ The door was open for longer than 15 minutes.	▶ Interior lighting switches off automatically after about 15 minutes when the door is open.

Defect	Cause	Remedy
	→ The LED interior light is faulty or the lid is damaged.	▶ Contact Customer Service. (see 10.4 Customer Service)

10.4 Customer Service

First check whether you can rectify the fault yourself (see 10 Customer help) . If you cannot rectify the problem, contact Customer Service.

You can find the address in the enclosed brochure “Liebherr-Service” or at home.liebherr.com/service.



WARNING

Unprofessional repair!
Injuries.

- ▶ Have any repairs and action - not expressly specified - on the appliance and mains cable carried out by service personnel only. (see 9 Maintenance)
- ▶ A damaged mains cable may only be replaced by the manufacturer, the manufacturer’s Customer Service or a similarly qualified person.
- ▶ In the case of appliances with an IEC connector, the change may be made by the customer.

10.4.1 Contacting Customer Service

Make sure that the following appliance information is available:

- Appliance name (model and index)
- Service no. (Service)
- Serial no. (S no.)

▶ Call up the appliance information via the display.

-or-

- ▶ Refer to the type plate for appliance information. (see 10.5 Model plate)
- ▶ Note down the appliance information.
- ▶ Notify customer service: Report errors and the appliance information.
- ▶ This will help us to provide you with a faster, more accurate service.
- ▶ Follow further instructions from Customer Service.

10.5 Model plate

The type plate is located on the bottom left of the inside of the appliance.

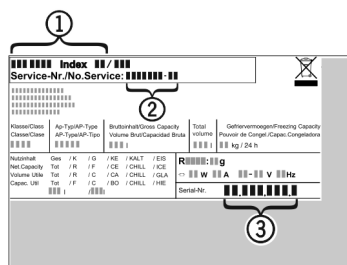

Fig. 93

- (1)** Appliance description **(3)** Serial no.
(2) Service no.

- ▶ Note the data on the model plate.

11 Shutting down

- ▶ Empty the appliance.
- ▶ Switch off appliance. (see 7.2.2 Switching appliance on and off)
- ▶ Pull the mains plug out of the socket.
- ▶ Remove the IEC socket if required: Pull the IEC socket out of the appliance plug and move it to the left and right at the same time.
- ▶ Clean appliance. (see 9.2 Cleaning the appliance)
- ▶ Leave the door open, so that no unpleasant odours arise.

12 Disposal

12.1 Preparing appliance for disposal



Liebherr uses batteries in some of its appliances. In the EU, for environmental reasons, legislation obliges the end user to remove these batteries before disposing of old appliances. If your appliance contains batteries, a corresponding notice is attached.

Lamps

If you can remove the lamps yourself without destroying them, also remove these before disposal.

- ▶ Take the appliance out of operation.
- ▶ If possible: remove lamps without destroying them.

12.2 Disposing of the appliance in an environmentally friendly manner



The appliance still contains valuable materials and must be disposed of separately from unsorted municipal waste.



Dispose of batteries separately from the old appliance. To do this, you can return the batteries free of charge to retailers as well as recycling centres and collection centres for recyclable materials.

Lamps

Dispose of removed lamps via the respective collection systems.

For Germany:

You can dispose of the appliance free of charge via the class 1 collection containers at the local recycling and recyclable material collection centres. When purchasing a new fridge/freezer, if the sales area > 400 m², retailers will also take back the old appliance free of charge.

Disposal



WARNING

Leaking coolant and oil!

Fire. The coolant contained in the appliance is eco-friendly, but also flammable. The oil contained in the appliance is flammable. Escaping coolant and oil can ignite if the concentration is high enough and in contact with an external heat source.

- ▶ Do not damage the pipelines of the coolant circuit and the compressor.
-
- ▶ Observe the notes on transporting the appliance.
 - ▶ Transport the appliance without damaging it.
 - ▶ Dispose of batteries, lamps and the appliance according to the above specifications.



home.liebherr.com/fridge-manuals

EN wine storage

Issue date: 20250514

Part number index: 7080556-00

Liebherr-Hausgeräte GmbH
Memminger Straße 77-79
88416 Ochsenhausen
Deutschland