

gorenje

EN

GB

IE

INSTRUCTIONS FOR USE

Induction hob

GI6432BSCE

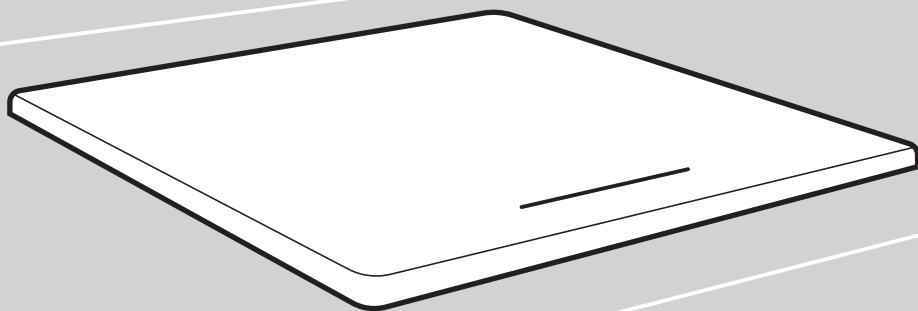

Warning notices: Before using this product, please read this manual carefully and keep it for future reference. The design and specifications are subject to change without prior notice for product improvement.

Consult with your dealer or manufacturer for details.

The diagram above is just for reference. Please take the appearance of the actual product as the standard.

We thank you for your trust and the purchase of our appliance.

This detailed instruction manual is supplied to make the use of this product easier. The instructions should allow you to learn about your new appliance as quickly as possible.

Make sure you have received an undamaged appliance. If you do find transport damage, please contact the seller from which you purchased the appliance, or the regional warehouse from which it was supplied. The telephone number can be found on the invoice or on the delivery note.

Instructions for use are also available at our website:

www.gorenje.com / < <http://www.gorenje.com> />.



INFORMATION!

Information, advice, tip, or recommendation



WARNING!

Warning – general danger

CONTENTS







1. SAFETY INSTRUCTIONS	4
2. SAFETY WARNINGS	5
2.1. Installation.....	5
2.2. Operation and maintenance.....	6
3. PRODUCT OVERVIEW	10
3.1. Top View.....	10
3.2. Control Panel.....	10
4. OPERATION INSTRUCTIONS	11
4.1. Touch Controls	11
4.2. Choosing.....	11
4.3. Pan Dimension	12
4.4. How to Use	13
5. QUICK START GUIDE	20
6. PRODUCT INSTALLATION	22
7. CLEANING AND MAINTENANCE	29
8. TROUBLESHOOTING	30
9. DISPOSAL AND RECYCLING	33

1. SAFETY INSTRUCTIONS

Intended Use

The following safety instructions are intended to prevent unforeseen hazards or damage caused by unsafe or incorrect operation of the appliance. Please check the packaging and the appliance on arrival to ensure that everything is intact to ensure safe operation. If you find any damage, please contact the dealer or seller. Please note that modifications or changes to the appliance are not permitted for safety reasons. Improper use can lead to hazards and the loss of warranty claims.

Explanation of Symbols

	Danger This symbol indicates that there are dangers to the life and health of persons due to extremely flammable gas.
	Warning of electrical voltage This symbol indicates that there is a danger to life and health of persons due to voltage.
	Warning The signal word indicates a hazard with a medium level of risk which, if not avoided, may result in death or serious injury.
	Caution The signal word indicates a hazard with a low degree of risk which, if not avoided, may result in minor or moderate injury.
	Attention The signal word indicates important information (e.g. damage to property), but not danger.
	Observe instructions This symbol indicates that a service technician should only operate and maintain this appliance in accordance with the operating instructions.

Read these operating instructions carefully and attentively before using/starting up the appliance and keep them in the immediate vicinity of the installation site or the appliance for later use!

2. SAFETY WARNINGS

Your safety is important to us. Please read this information before using your cooktop.

2.1. Installation

Electrical Shock Hazard

- Disconnect the appliance from the mains before carrying out any work or maintenance on it.
- Connection to a properly earthed mains supply is essential and mandatory.
- Changes to the domestic installation may only be carried out by a qualified electrician.
- Failure to observe this instruction may result in electric shock or death.

Cut Hazard

- Take care - panel edges are sharp.
- Failure to use caution could result in injury or cuts.

Important Safety Instructions

- Read these instructions carefully before installing or using the appliance.
- Do not place flammable materials or products on the appliance at any time.
- Please pass this information on to the person responsible for installing the appliance, as this could reduce your installation costs.
- To avoid a hazard, this appliance must be installed in accordance with these installation instructions.
- This appliance must only be properly installed and earthed by a suitably qualified person.
- This appliance must be connected to a circuit that has a disconnect switch to ensure complete isolation from the mains supply.
- Failure to install the appliance correctly may invalidate any warranty or liability claims.
- This appliance can be used by children aged from 8 years and above and persons with reduced physical, sensory or mental capabilities or lack of experience and knowledge if they have been given supervision or instruction concerning use of the appliance in a safe way and understand the hazards involved.

- Children shall not play with the appliance. Cleaning and maintenance by the user must not be carried out by children without supervision.
- If the power cord is damaged, it must be replaced by the manufacturer, its service agent or a similarly qualified person in order to avoid a hazard.
- **WARNING!** If the surface is cracked, switch off the appliance to avoid the possibility of electric shock on hob surfaces made of glass ceramic or similar material that protect live parts
- Metal objects such as knives, forks, spoons and lids should not be placed on the cooktop as they can become hot
- A steam cleaner must not be used.
- Do not use a steam cleaner to clean your cooktop.
- The appliance must not be operated with an external timer or a separate remote control system.
- **WARNING!** Fire hazard: do not place any objects on the cooking surfaces.
- The cooking process must be supervised. A short-term cooking process must be constantly monitored.
- **WARNING!** Unattended cooking on a hob with fat or oil can be dangerous and lead to a fire. NEVER attempt to extinguish a fire with water, but switch off the appliance and cover the flame with a lid or fire blanket, for example.

2.2. Operation and maintenance

Electrical Shock Hazard

- Do not cook on a broken or cracked cooking surface. If the cooktop is broken or cracked, turn off the appliance immediately at the power switch and contact a qualified technician.
- Switch the cooktop off at the wall switch before cleaning or maintenance.
- Failure to follow this instruction may result in electric shock or death.

Health Hazard

- This appliance complies with electromagnetic safety standards.
- However, persons with pacemakers or other electrical implants (e.g. insulin pumps) must consult their doctor or the manufacturer of the implant before using this appliance to ensure that their implants are not affected by the electromagnetic field.
- Failure to comply with this instruction may result in death.

Hot Surface Hazard

- During use, accessible parts of this appliance may become so hot that they can cause burns.
- Do not allow your body, clothing or anything other than suitable cookware to come into contact with the induction glass until the surface has cooled down.
- Keep children away.
- The handles of pots can be hot to the touch. Make sure that the handles of the pots do not protrude over other cooking zones that are switched on. Keep the handles out of the reach of children.
- Failure to observe this instruction can lead to burns and scalds.

Cut Hazard

- The razor-sharp blade of a cooktop scraper is exposed when the safety cover is retracted. Use with extreme care and always store safely and out of reach of children.
- Failure to use caution could result in injury or cuts.

Important safety instructions

- Never leave the appliance unattended when in use. Boil-over causes smoking and greasy spillovers that may ignite.
- Never use your appliance as a work or storage surface.
- Never leave any objects or utensils on the appliance.
- Do not place or leave any objects that can be magnetized (e.g. credit cards, memory cards) or electronic devices (e.g. computers, MP3 players) near the appliance, as they may be affected by its electromagnetic field.
- Never use your appliance for warming or heating the room.
- After use, always turn off the cooking zones and the cooktop as described in this manual (i.e. by using the touch controls). Do not rely on the pan detection feature to turn off the cooking zones when you remove the pans.
- Do not allow children to play with the appliance or sit, stand, or climb on it.
- Do not store items of interest to children in cabinets above the appliance. Children climbing on the cooktop could be seriously injured.
- Do not leave children alone or unattended in the area where the appliance is in use.

- Children or persons with a disability which limits their ability to use the appliance should have a responsible and competent person to instruct them in its use. The instructor should be satisfied that they can use the appliance without danger to themselves or their surroundings.
- Do not repair or replace any part of the appliance unless specifically recommended in the manual. All other servicing should be done by a qualified technician.
- Do not place or drop heavy objects on your cooktop.
- Do not stand on your cooktop.
- Do not use pans with jagged edges or drag pans across the Induction glass surface as this can scratch the glass.
- Do not use scourers or any other harsh abrasive cleaning agents to clean your cooktop, as these can scratch the Induction glass.
- This appliance is intended to be used in household and similar applications such as: staff kitchen areas in shops, offices and other working environments; farm houses; by clients in hotels, motels and other residential type environments; bed and breakfast type environments.
- **WARNING:** The appliance and its accessible parts become hot during use.
- Care should be taken to avoid touching heating elements.
- Children less than 8 years of age shall be kept away unless continuously supervised.
- After use, switch of the hob element by its control and do not rely on the pan detector.

Congratulations on the purchase of your new Induction Hob.

We recommend that you spend some time to read this Instruction / Installation Manual in order to fully understand how to install correctly and operate it.

For installation, please read the installation section.

Read all the safety instructions carefully before use and keep this Instruction / Installation Manual for future reference.

SPECIFICATIONS

Cooking Hob	GI6432BSCE
Cooking Zones	4 Zones
Supply Voltage	220-240V~ 380-415V 3N~ 50Hz or 60Hz
Installed Electric Power	7400W
Product Size D×W×H(mm)	590X520X53
Building-in Dimensions A×B (mm)	560X480

Weight and Dimensions are approximate. Because we continually strive to improve our products we may change specifications and designs without prior notice.

3. PRODUCT OVERVIEW

3.1. Top View

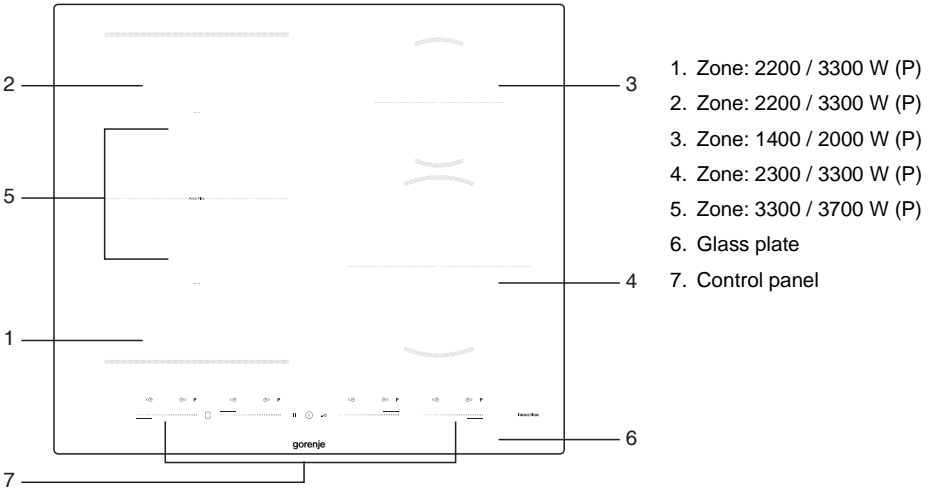

3.2. Control Panel

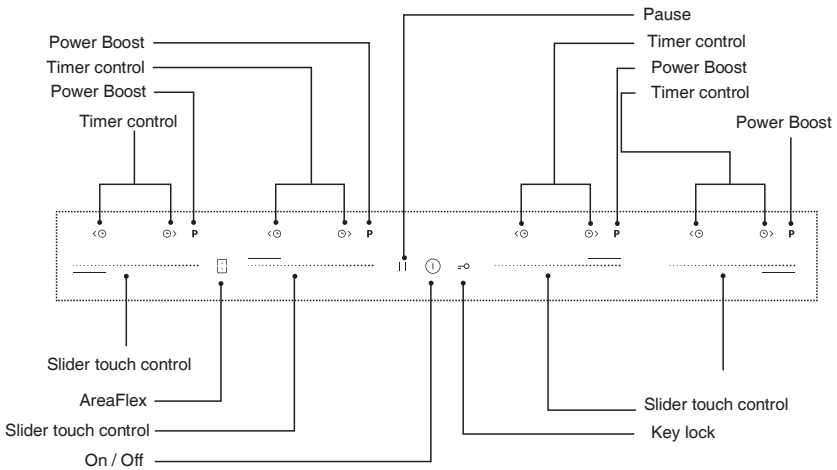

NOTE

All images in this manual are for explanatory purposes only. Any discrepancy between the real object and the illustration in the drawing is subject to the real object.

Working Theory

Induction cooking is a safe, advanced, efficient and economical cooking technology. It works by electromagnetic vibrations that generate heat directly in the pan and not indirectly by heating the glass surface. The glass only gets hot because the pan eventually heats it up.

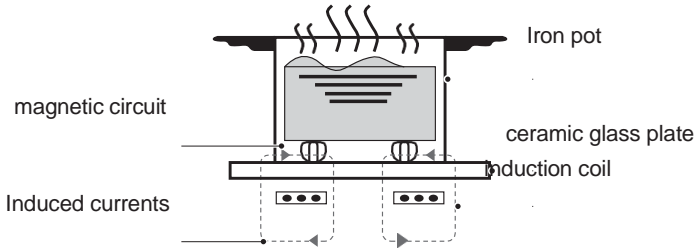

Before Using Your New Induction Hob

- Read this guide, taking special note of the 'Safety Warnings' section.
- Remove any protective film that may still be on your Induction hob.

4. OPERATION INSTRUCTIONS

4.1. Touch Controls

- The controls respond to touch, so you do not need to apply any pressure.
- Use the ball of your finger, not the tip.
- Each time a touch is registered, a beep sounds.
- Make sure that the operating elements are always clean and dry and that no object (e.g. a utensil or cloth) is placed on them. Even a thin film of water can make it difficult to operate the controls.

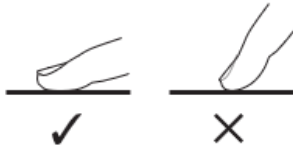

4.2. Choosing



- Only use cookware with a base suitable for induction cooking.
- Look for the induction symbol on the packaging or on the base of the pan.
 - You can check whether your cookware is suitable with a magnet test.
 - Hold a magnet to the base of the pan. If it is attracted, the pan is suitable for induction.

- If you do not have a magnet:
 1. Put some water in the pan you want to check.
 2. If \cup does not flash in the display and the water is heating, the pan is suitable.
- Cookware made of the following materials is not suitable: pure stainless steel, aluminium or copper without a magnetic base, glass, wood, porcelain, ceramic, and earthenware.
- Cookware bases with aluminium content.
- These reduce the ferromagnetic range, which means that less energy is transferred to the cookware, resulting in this cookware not being recognised sufficiently or not at all and therefore not being heated sufficiently.

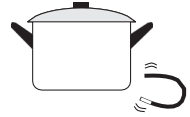

- Do not use cookware with jagged edges or a curved base.



- Make sure that the base of your pan is smooth, lies flat against the glass and is the same size as the cooking zone. Use pans whose diameter is the same size as the graphic of the selected zone. If you use a pan that is slightly larger, the energy will be used to the maximum. If you use a smaller pan, the power may be lower than expected. Pots with a diameter of less than 140 mm may not be recognised by the hob. Always place your pot in the centre of the cooking zone.

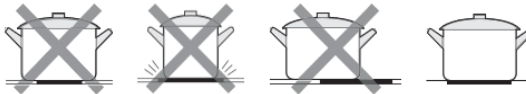

- Always lift pans from the Induction hob – do not slide, as they may scratch the glass.

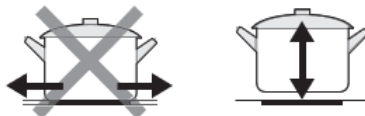

4.3. Pan Dimension

The cooking zones are automatically adjusted to the diameter of the pan up to a certain limit. However, the base of the pan must have a minimum diameter corresponding to the cooking zone. To achieve the best efficiency of your hob, please place the pan in the middle of the cooking zone

Cooking zone	The base diameter of induction cookware	
	Minimum (mm)	Maximum (mm)
1,2	120	220
3	100	150
4	140	210
flex induction	210	220x380

4.4. How to Use

Start Cooking

- Touch the ON/OFF button. After switching on, a signal tone sounds and “ - ” is displayed on the control elements for selecting the heating zones , which means that the induction hob is in standby mode.



- Place a suitable pan on the cooking zone that you wish to use.
 - Make sure the bottom of the pan and the surface of the cooking zone are clean and dry.

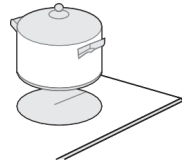

- Each hob has its own independent slider, boost, timing operation button, which can independently operate the power level/timing function.
- Adjust heat setting by touching the slider control.
 - If you don't choose a heat setting within 20 seconds, the Induction hob will automatically switch off. You will need to start again at step 1.
 - You can modify the heat setting at any time during cooking.



If the display flashes alternately with the heat setting

This means that:

- You have not placed a pan on the correct cooking zone or,
- The pan you are using is not suitable for induction cooking or,
- The pan is too small or is not correctly centered on the cooking zone.

Heating only takes place if there is a suitable pan on the cooking zone. The display switches off automatically after 1 minute if there is no suitable cookware on the cooking zone.

Finish Cooking

- Move the slider of the corresponding burner all the way to the left, make sure that the display shows "0", after 3s the hob is switched off and the display shows "-".

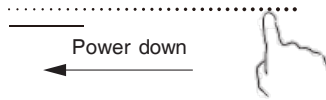

- Turn the whole cooktop off by touching the ON/OFF control.



- Beware of hot surfaces

H/h indicates which cooking zone is hot to the touch. It disappears when the surface has cooled down to a safe temperature. It can also be used as an energy saving function, if you want to heat more pans, use the hotplate while it is still hot.



Using the Boost Function

Activate the boost function

- Touch the ON/OFF button. After switching on, a signal tone sounds and " - " is displayed on the control elements for selecting the heating zones, which means that the induction hob is in standby mode.
- By touching the boost control "P", the zone display shows "Marquee" and the power reaches maximum level.



Cancel the Boost function

- while the boost mode is running, touching any level on the slider will stop the boost mode and the selected level will be shown in the display area.

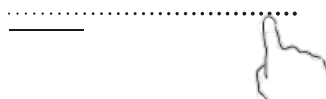

- After the boost operating time has reached 10 minutes, boost mode is automatically terminated and the level before entering boost mode is reached again. If the level before entering boost mode is 0, it is set to level 9 for operation.

NOTE

- The function can work in all cooking zones
- The cooking zone returns to its original setting after 10 minutes.
- The flex cooking zone returns to its original setting after 5 minutes.
- If the boost function of the 1st cooking zone is activated, the highest power level at the 2nd cooking zone, is 3 and vice versa.
- If the original heat setting is 0, it will return to 9 after the boost function has ended.

Flexible Area

- This area can be used as a single zone or as two different zones, depending on the needs of cooking at any given time.
- The flexible zone consists of two independent inductors that can be controlled separately. When used as a single zone, the part not covered by the cookware is automatically switched off after 8 seconds.
- To ensure correct detection of the pan and even heat distribution, the cookware should be positioned correctly:
 - At the front or back of the flexible zone if the cookware is smaller than 21 cm.
 - Everywhere with larger cookware.
 - To activate the flexible area as a single large zone, simply press the corresponding button.



Examples of good pot placement and bad pot placement.

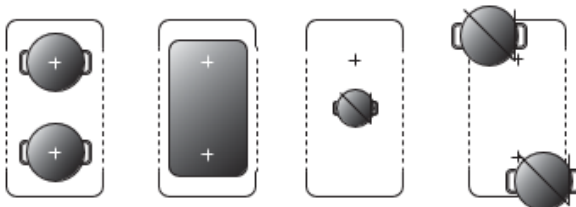



Locking the Controls

- You can lock the controls to prevent unintentional use (e.g. if children accidentally switch on the cooking zones).
- When the controls are locked, all controls except the ON/OFF button are deactivated.

To lock the controls	
Touch the lock control	The digital will show "Lo"
To unlock the controls	
Touch and hold the lock control for a while.	



When the cooktop is in lock mode, all controls except ON/OFF  are deactivated. You can always switch off the induction hob in an emergency using the  ON/OFF control, but you must first unlock the hob the next time you operate it.

Timer Control

- Each heating zone has independent buttons for increasing and decreasing the time.
- A short press of the button increases or decreases the time by 1 minute, a long press increases or decreases it by 10 minutes.
- If Flex mode is active, the time control buttons of 1st cooking zone can control the time of the Flex zone.
- In flex zone mode, if the time setting is present, with turn off the flex zone function, the time will remain just on the front cooking zone.
- When you switch to flex mode, the time setting is switched off by default.
- The maximum time that can be set is 8:00 (Hours).
- The maximum setting time of the current cooking zone depends of the power level. For more information, see Standard working times.
- Click on the slider to display the current power level and move the slider to adjust the level.

1. Press the Timer button, the time is set to 0, set time within 3s.

0:00

2. The button for increasing the time is effective for long and short presses



3. The button for decreasing the time is effective for long and short presses.



4. Press the plus or minus button simultaneously for 1s to cancel the time measurement.



Pause

1. When the cooking zones are in operation, touch the “||” button, all displays show “.” and heating at level 2. At this moment, only the “||” and “ⓐ” controls can be operated.
2. Touch “||” again, the displays will show the original setting and the cooking zones will continue to heating up



Pan transfer

The pan transfer function is deactivated by default and can be switched on or off as follows

When switched off, press and hold the opening button “ⓐ” to start the hob. Then within 10 seconds press the time reduction function button of the LF cooking zone for 3s;

1. If "On" is shown on the LF digital display, this means that the pot transfer function is activated.
2. If the LF digital display shows "Off", this means that the pan transfer function is deactivated.
3. If the cooking zone is in boost mode, the pan transfer function is not activated by default.
4. Once the transfer has been confirmed, the time and power level are transferred

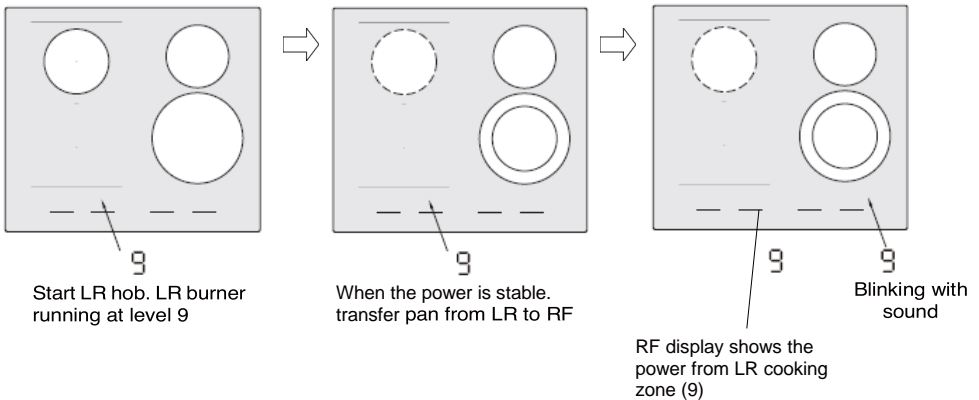

Confirmation

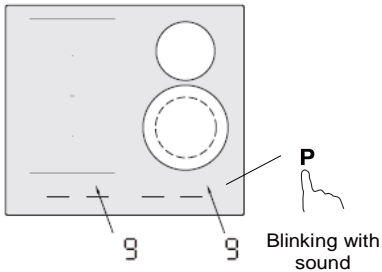

Press the flashing burner's boost key to confirm the transfer

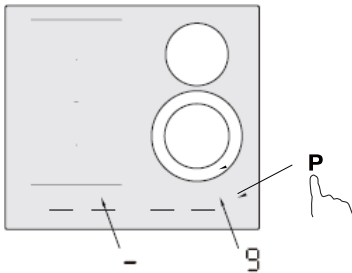

RF burner is heated at LR burner level

Disconfirmation

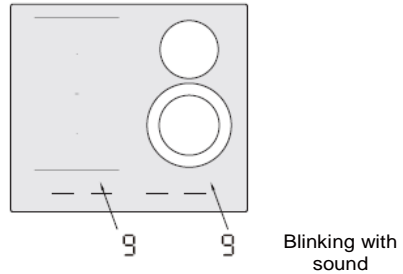

1. No pot is displayed after 6 seconds
2. 10 seconds later, turn of the blinking and prompt sound

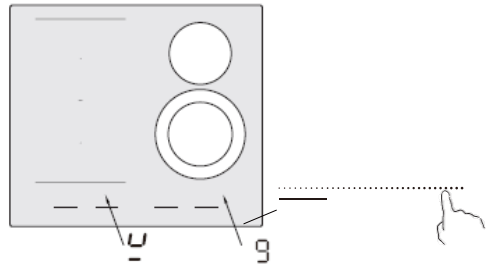

Operate the RF slide. cancel the transfer and heat in the set

Default Working Times

The automatic switch-off is a safety protection function for your induction hob. It switches off automatically if you forget to switch off the hob. The standard operating times for the various power levels are listed in the following table:

Power level	pause	1	2	3	4	5	6	7	8	9
Default working timer (hour)	8	8	8	6	6	4	4	2	2	1,5

When the pot is removed, the induction hob stop heating immediately and the hob automatically switch off after 1 minutes.



People with a pacemaker should consult their doctor before using this device.

Power Management Function

It is possible to set a maximum power consumption for the induction hob and choose between different power ranges.

Induction hobs are able to limit themselves automatically to operate at lower power to avoid the risk of overloading

To enter Power Management Function

1. Switch off the appliance with pressing "power" key. Pressing "Child Lock" key for 3 seconds into child lock state.

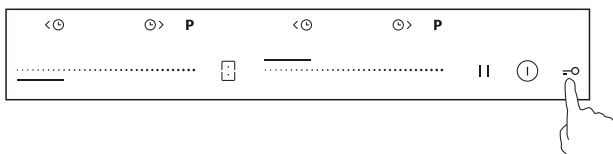

2. Pressing "Boost" key of left rear hob for 3 seconds.
After you enter Step 2, a short buzzer sound will be heard.

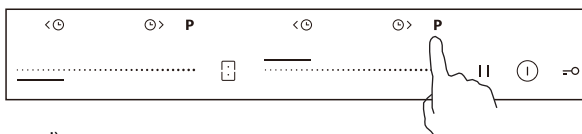

3sec (+ buzzer sound)

3. After buzzer sound, power-management function is successfully entered and the number "74" (for 7,4 kW) is displayed.

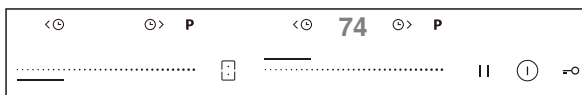

To switch to another level

1. Short press the "child lock" key . There are 6 power levels, from "7,4" to "2,5". The LR indicator will show one of them:
 - "74" : the maximum power is 7,4 kW
 - "60" : the maximum power is 6,0 kW
 - "45" : the maximum power is 4,5 kW
 - "35" : the maximum power is 3,5 kW
 - "30" : the maximum power is 3,0 kW
 - "25" : the maximum power is 2,5 kW

Confirmation and exit Power Management Function

1. After the desired power setting mode is selected, please press power key  to exit and save.

5. QUICK START GUIDE



Be careful when deep-frying, as oil and fat heat up very quickly, especially when using PowerBoost. At extremely high temperatures, oil and fat will ignite spontaneously, posing a serious fire hazard

Cooking Tips

- When the food is boiling, reduce the temperature.
- Using a lid shortens the cooking time and saves energy as it retains the heat.
- Reduce the amount of liquid or fat to shorten the cooking time.
- Start cooking at a high level and reduce the level when the food is cooked through.

Simmering, Cooking rice

- Simmering takes place below the boiling point, at around 85°C, when bubbles occasionally rise to the surface of the cooking liquid. It is the key to delicious soups and delicate stews because it allows the flavours to develop without overcooking the food. You should also cook egg-based sauces and sauces thickened with flour below the boiling point.
- For some cooking methods, such as cooking rice using the absorption method, it may be necessary to set a higher setting than the lowest setting to ensure that the food is cooked properly in the recommended time.

Searing Steak

To cook juicy flavorsome steaks:

1. Leave the meat to stand at room temperature for about 20 minutes before cooking.
2. Heat a heavy frying pan.
3. Brush both sides of the steak with oil. Drizzle a small amount of oil into the hot pan and then place the meat in the hot pan.
4. Turn the steak only once during cooking. The exact cooking time depends on the thickness of the steak and how well done you want it. The time can vary between 2 and 8 minutes per side. Press on the steak to check how cooked through it is – the firmer it feels, the better cooked through it is.
5. Allow the steak to rest on a warm plate for a few minutes before serving so that it can relax and become tender.

For Stir-frying

1. Choose an induction-compatible flat wok or a large frying pan.
2. Have all the ingredients and utensils ready. Stir-frying should be quick. If you are preparing large quantities, cook the food in several smaller batches.
3. Preheat the pan briefly and add two tablespoons of oil.
4. Cook the meat first, set aside and keep warm.
5. Stir-fry the vegetables. When hot but still crisp, turn the heat down to low, return the meat to the pan and add the sauce.
6. Stir the ingredients gently so that they are heated through.
7. Serve immediately.

Detection of Small Articles

If a pan of unsuitable size or a non-magnetic pan (e.g. aluminium) or another small item (e.g. knife, fork, key) is left on the cooktop, the hob automatically switches to standby after 1 minute. The fan continues to work for another 1 minute.

Heat Settings

The settings below are only guidelines. The exact setting will depend on several factors, including your cookware and the amount you are cooking. Experiment with the induction hob to find the settings that suit you best.

Heat setting	Suitability
1 - 2	<ul style="list-style-type: none">• delicate heating of small quantities of food• melting chocolate, butter and foods that burn quickly• gentle simmering• slow heating
3 - 4	<ul style="list-style-type: none">• reheating• rapid simmering• cooking rice
5 - 6	<ul style="list-style-type: none">• pancakes
7 - 8	<ul style="list-style-type: none">• sautéing• cooking pasta
9/P	<ul style="list-style-type: none">• frying• sauté• bring soup to the boil• boiling water

6. PRODUCT INSTALLATION

Selection of Installation Equipment

Cut out the work surface according to the dimensions shown on the drawing.

A minimum clearance of 5 cm must be maintained around the hole for installation and use. Ensure that the thickness of the work surface is at least 30 mm. Choose a heat-resistant and insulated material for the work surface (wood and similar fibrous or hygroscopic materials must not be used as work surface material unless they are impregnated) to avoid electric shock and major deformation due to heat radiation from the heating plate. As shown below:

⚠ Note: The safety distance between the sides of the hob and the inner surfaces of the worktop should be at least 3 mm.

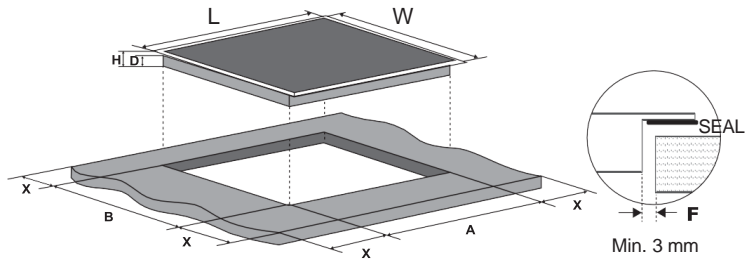

L(mm)	W(mm)	H(mm)	D(mm)	A(mm)	B(mm)	X(mm)	F(mm)
590	520	53	49	560±1	480±1	50 min	3 min

Under all circumstances, make sure that the induction hob is well ventilated and that the air inlets and outlets are not blocked. Make sure that the induction hob is in good working order. As shown below:

⚠ Note: The safety distance between the hotplate and the cupboard above the hotplate should be at least 650 mm.

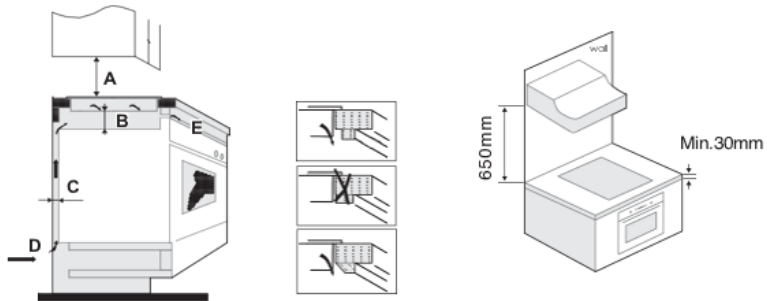

A(mm)	B(mm)	C(mm)	D	E
650 min	15 min	20 min	Air intake	Air exit 2mm

WARNING: Ensuring Adequate Ventilation

Ensure that the induction hob is well ventilated and that the air inlet and outlet are not blocked. To avoid accidental contact with the overheated bottom of the hob or an unforeseeable electric shock during work, it is necessary to install a wooden insert fixed with screws at a minimum distance of 15 mm from the bottom of the hob. Observe the following requirements:

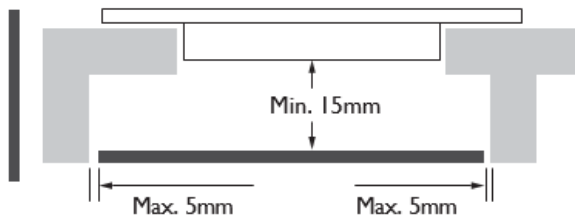

There are ventilation holes around outside of the hob. You need to ensure these holes are not blocked by the worktop when you put the hob into position.

- Make sure that the adhesive that bonds the plastic or wood material to the furniture cannot withstand a temperature of less than 150°C to prevent the cladding from coming loose.
- The back panel, the adjacent and surrounding surfaces must therefore be able to withstand a temperature of 90°C.

Before Installing the Hob, Make Sure That

- The work surface is rectangular and flat, and no structural elements interfere with the space required.
- The worktop is made of a heat-resistant and insulated material.
- If the hob is installed above an oven, the oven has a built-in cooling fan.
- The installation must comply with all clearance requirements and applicable standards and regulations.
- A suitable disconnect switch, which allows complete disconnection from the electrical supply, is integrated into the fixed wiring and is fitted and positioned to comply with local wiring rules and regulations.
- The disconnect switch shall be of an approved type and shall have a contact separation of 3 mm air gap in all poles (or in all active [phase] conductors if local wiring regulations permit this deviation from the requirements).
- The disconnect switch must be easily accessible to the customer when the hob is installed.
- If in doubt, consult local building authorities and regulations for installation.
- You use heat-resistant and easy-to-clean surfaces (e.g. ceramic tiles) for the wall surfaces around the hob.

After Installing the Hob, Make Sure That

- The power supply cable is not accessible through cupboard doors or drawers.
- There is a sufficient flow of fresh air from outside the cupboard to the base of the hob.
- If the hob is installed above a drawer or cupboard space, a heat protection barrier is fitted under the base of the hob.
- The isolating switch is easily accessible to the customer.

Before Locating the Fixing Brackets

The appliance should be placed on a stable, smooth surface (use the packaging). Do not apply force to the controls protruding from the hob.

Adjusting the Bracket Position

Secure the hob to the worktop by attaching 4 brackets to the underside of the hob before installation (see illustration).

Adjust the position of the brackets to different worktop thicknesses.

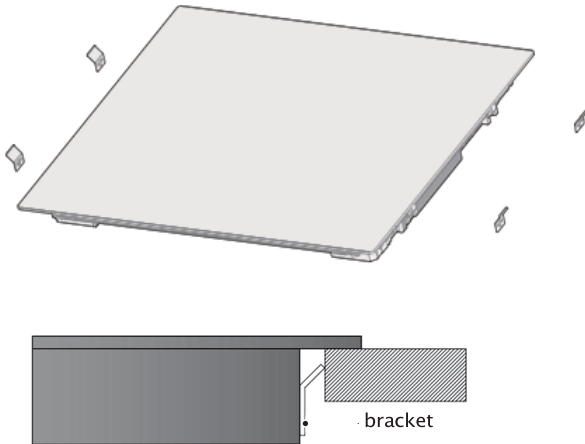

Under no circumstances should the brackets touch the inner surfaces of the worktop after installation (see illustration).

CAUTIONS

1. The induction hob must be installed by qualified personnel or technicians. We have specialists who are at your disposal. Please never repair the appliance by yourself.
2. Do not install the hob directly above a dishwasher, refrigerator, freezer, washing machine or tumble dryer, as the moisture can damage the hob's electronics.
3. The induction hob must be installed in such a way as to ensure better heat radiation in order to increase its reliability.

4. The wall and the induced heating zone above the table surface must be heat-resistant.
5. To avoid damage, the sandwich layer and the adhesive must be heat-resistant.
6. A steam cleaner must not be used.

Connecting the Hob to the Mains Power Supply

! This hob may be connected to the mains power supply only by a suitably qualified person. Before connecting the hob to the mains supply, check that:

1. The domestic installation is suitable for the power consumed by the hob.
2. The voltage corresponds to the value specified on the rating plate.
3. The cable sections for the power supply are suitable for the load specified on the rating plate.

Do not use adapters, reducers or branches to connect the hob to the mains supply, as they may cause overheating and pose a fire hazard.

The power supply cable must not touch any hot parts and must be routed so that its temperature does not exceed 75 °C at any point.

! Check with a qualified electrician whether the domestic installation is suitable without modifications. Modifications may only be carried out by a qualified electrician.

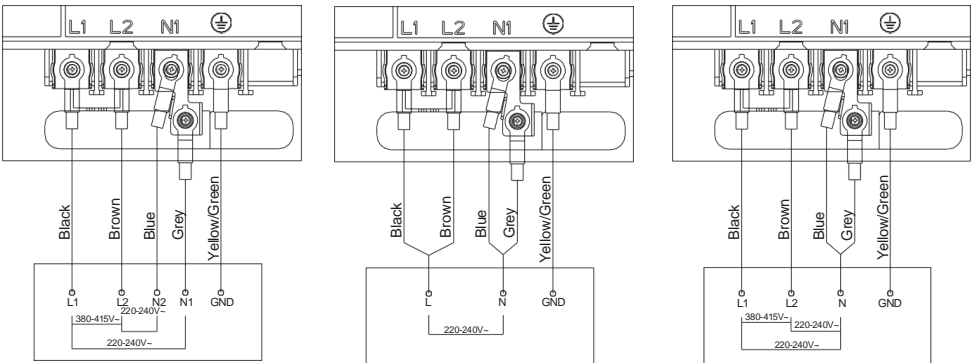

- If the cable is damaged or needs to be replaced, the operation must be carried out by customer service using suitable tools in order to avoid accidents.
- If the appliance is connected directly to the mains, an omnipolar circuit breaker with a minimum opening of 3 mm between the contacts must be installed.
- The installer must ensure that the electrical connection has been made correctly and in accordance with safety regulations.
- The cable must not be kinked or compressed.
- The cable must be checked regularly and replaced by authorised technicians.

! The bottom surface and the power cable of the hob are not accessible after installation.

Flush-mount Installation Into The Worktop

Appliances without faceted edges or decorative frames, are suitable for flush mounting.



Installing the appliance

The appliance may only be installed into a temperature- and water-resistant countertop, such as a countertop made of (natural) stone (marble, granite), or solid wood (the edges along the cut-out have to be sealed). When installing into a countertop made of ceramics, wood, or glass, a wooden sub-frame should be used. The frame is not supplied with the appliance. The appliance may only be installed into a countertop made of other materials after you have consulted the countertop manufacturer and obtained his express approval. Internal dimension of the basic unit should be at least equal to the internal cutout for the appliance. This will allow simple removal of the appliance from the countertop.

Attach sealing tape along the perimeter of the bottom of the glass panel.

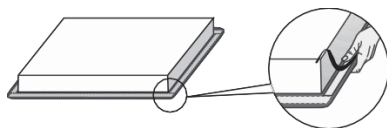

First, feed the power cord through the cutout. Place the appliance over the center of the cutout. Connect the appliance to the power mains (see instructions for connecting the appliance). Before sealing the appliance, test its operation. Seal the slot between the appliance and the countertop using a silicone sealant. The silicone sealant used to seal the appliance has to be temperature-resistant (to at least 160 °C). Smooth out the silicone sealant using a suitable tool. Observe the instructions for use of the selected silicone sealant. Do not switch on the appliance until the silicone sealant has dried completely.

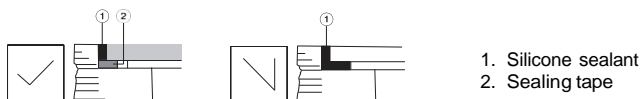

WARNING!

Pay particular attention to built-in dimensions with (natural) stone countertops. When choosing the silicone sealant, observe the countertop material and consult the countertop manufacturer. Use of inappropriate.

Removing the built-in appliance

Disconnect the appliance from the power mains. Use a suitable tool to remove the silicone gasket from the perimeter. Remove the appliance by pushing it upwards from the bottom side.

WARNING!

Do not attempt to remove the appliance from the upper side of countertop.

WARNING!

The service department shall only be responsible for repair and servicing of the cooking hob. Consult your specialized kitchen equipment dealer regarding the re-installation (of the flush-mount)

Stone countertop

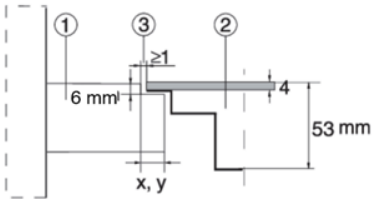

- 1. Countertop
- 2. Appliance
- 3. Slot

Given the margin of error (tolerance) for the glass ceramic plate of the appliance, and the cutout in the countertop, the slot is adjustable (min.2 mm).

Ceramic, wooden, or glass countertop

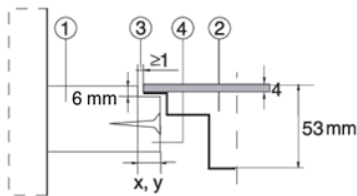

- 1. Countertop
- 2. Appliance
- 3. Slot
- 4. Wooden frame, thickness 16 mm

Given the margin of error (tolerance) for the glass ceramic plate of the appliance, and the cut-out in the countertop, the slot is adjustable (min. 2 mm). Install the wooden frame 5,5 mm below the upper edge of the countertop (see figure).

Observe the radii of glass edges (R3) when making the cut-out.

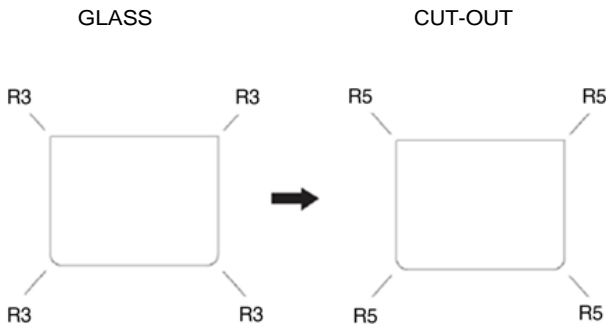

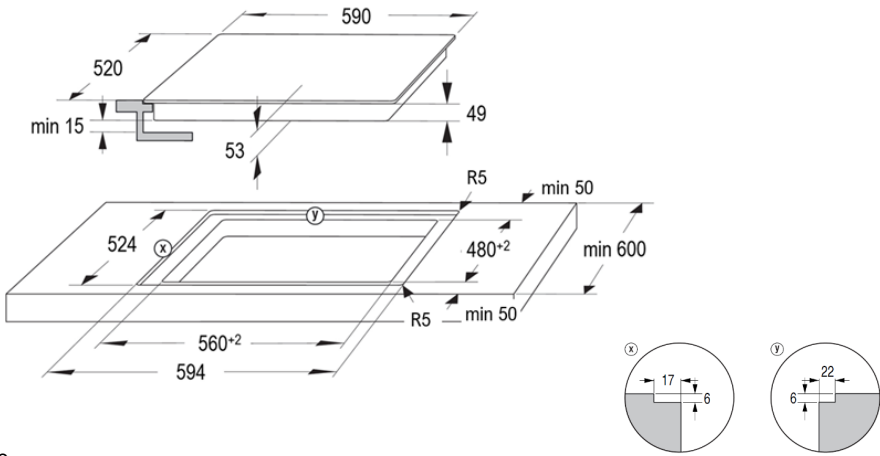

60cm

WARNING!

If the oven is installed under a flush-mounted cooking hob, then the worktop thickness should be at least 40 mm.

7. CLEANING AND MAINTENANCE

What?	How?	Important!
<p>Everyday soiling on glass (fingerprints, marks, stains caused by food or non-sugar-containing liquids on the glass)</p>	<ol style="list-style-type: none"> 1. Switch off the power to the hob. 2. Apply a hob cleaner while the glass is still warm (but not hot!) 3. Rinse it and wipe it dry with a clean cloth or paper towel. 4. Switch the power supply to the cooktop back on. 	<ul style="list-style-type: none"> • If the power supply to the hob is switched off, no "hot surface" is displayed, but the cooking zone may still be hot! Be extremely careful. • Heavy abrasive cleaners, some nylon washers and harsh/abrasive cleaners may scratch the glass. Always read the label to check that your cleaner or scouring pad is suitable. • Never leave any cleaning residue on the hob: the glass may become stained
<p>Boiling, melting and hot sugar residue on the glass.</p>	<p>Remove them immediately with a fish knife, a spatula or a razor scraper suitable for glass ceramic cooktops, but be careful of the hot surfaces of the cooking zone:</p> <ol style="list-style-type: none"> 1. Turn off the power supply to the hob at the wall. 2. Hold the blade or utensil at a 30° angle and scrape the dirt or spill to a cool spot on the cooktop. 3. Wipe up the spill or spilled drink with a tea towel or paper towel. 4. Carry out steps 2 to 4 for "Everyday soiling on glass" 	<ul style="list-style-type: none"> • Remove stains from melted and sugary foods or spilled liquids as quickly as possible. If they cool on the glass, they may be difficult to remove or even permanently damage the glass surface. • Cutting hazard: The blade of a scraper is razor sharp when the safety cover is retracted. Use it with extreme caution and always keep it safe and out of the reach of children.
<p>Spillovers on the touch controls.</p>	<ol style="list-style-type: none"> 1. Switch off the power supply to the hob. 2. Vacuum up the spilled contents. 3. Wipe the touch control area with a clean, damp sponge or cloth. 4. Wipe the area completely dry with a paper towel. 5. Switch the power supply to the cooktop back on. 	<ul style="list-style-type: none"> • The cooktop may beep and turn itself off, and the touch controls may not work if there is liquid on them. Make sure you wipe the touch control area dry before turning the cooktop back on.

8. TROUBLESHOOTING

The operation of your appliance can lead to faults and malfunctions. The following tables contain possible causes and instructions for rectifying an error message or fault. It is recommended that you read the following tables carefully to save time and money that a call to customer service can cost.

Problem	Possible causes	What to do
The hob cannot be switched on.	No power.	Make sure that the ceramic hob is connected to the mains and switched on. Check if there is a power cut in your house or area. If you have checked everything and the problem persists, call a qualified technician
The touch controls do not respond.	The controls are locked.	Unlock the controls. Refer to the "Using the Cooktop" section for instructions
The touch controls are difficult to operate.	There may be a light film of water on the controls or you may be touching the controls with your fingertip.	Make sure the area around the controls is dry and touch the controls with the pad of your finger.
The glass is scratched.	Coarse-edged cookware. Unsuitable, abrasive scouring or cleaning agents are being used.	Use cookware with flat and smooth bases. See "Choosing the right cookware". See "Cleaning and maintenance".
Some pans make crackling or clicking noises.	This may be caused by the construction of your cookware (layers of different metals that vibrate differently).	This noise is normal for cookware and does not indicate a fault.
The induction hob makes a low humming noise when it is operated at a high level.	This is due to the technology of induction cooking	This is normal, but the noise should become quieter or disappear completely if you reduce the heat setting
Blowing noises from the induction hob.	A cooling fan built into your induction hob has switched on to protect the electronics from overheating. It may continue to run even if you have switched off the induction hob	This is normal and does not require any action. Do not switch the induction hob off at the wall while the fan is running.
Pans do not get hot and do not appear in the display	The induction hob cannot recognise the pan because it is not suitable for induction cooking. The induction hob cannot detect the pan because it is too small for the cooking zone or is not correctly centred on the cooking zone.	Use cookware suitable for induction cooking. See section "Choosing the right cookware". Place the pan in the middle and make sure that its base corresponds to the size of the cooking zone

Problem	Possible causes	What to do
The induction hob or a cooking zone has switched off unexpectedly, a sound is emitted and an error code is displayed (usually alternating with one or two digits in the cooking timer display)	Technical fault.	Please make a note of the error letters and numbers, switch off the induction hob at the wall and contact a qualified technician.

Failure Display and Inspection

The induction hob is equipped with a self-diagnostic function. This test allows the technician to check the function of various components without removing the hob or taking it off the Kitchen Worktop.

(1) Troubleshooting

Problem	Possible causes	What to do!
E1, E2, E7	Failure of the temperature sensor	Please contact the supplier.
E3, E4	Failure of the temperature sensor of the IGBT	Please contact the supplier.
EU	The connection between the display board and the main board has failed or the communication of the touch IC has failed	Please contact the supplier.
EL / EH	Abnormal supply voltage.	Please check whether power supply is normal. Switch on the appliance if the power supply is OK.
C1	The temperature sensor of the glass ceramic plate is too high	Please restart the appliance after the induction hob has cooled down
C2	The temperature sensor of the IGBT is too high	Please restart the appliance after the induction hob has cooled down
F5	Abnormality of the fan.	Please contact the supplier.
EF	Two or more buttons are triggered over a long period of time.	Cleaning the operation area

(2) Specific Failure & Solution

Failure	Problem	Solution A	Solution B
The LED does not light up when the device is plugged in	No power supply.	Check that the plug is firmly seated in the socket and that the socket is working	
	The additional board and the display board are defective	Check the connection.	
	The additional power board is damaged.	Replace the additional circuit board	
	The display board is damaged.	Replace the display board.	
Some buttons do not work or the LED display is not normal	The display board is damaged.	Replace the display board.	
The cooking mode indicator lights up, but the heating process does not start	High temperature of the hob.	The ambient temp. may be too high. The air inlet or ventilation may be blocked	
	Something is wrong with the fan.	Check whether the fan runs properly, if not, replace the fan.	
	The power board is damaged.	Replace the power board.	
The heating process is suddenly interrupted during operation and “ <u>u</u> ” flashes on the display.	The pan type is wrong.	Use the correct pot (see instructions for use)	Pan detection circuit is damaged, replace the motherboard.
	The pot diameter is too small.		
	The hob has overheated;	The appliance has overheated. Wait until the temperature returns to normal. Press the “ON/OFF” button to restart the appliance	
Heating zones on the same side (e.g. the first and second zones) would display “ <u>u</u> ”.	The power supply board and the display board are not connected	Check the connection.	
	The display board of the communication part is damaged	Replace the display board.	
	The Main board is damaged.	Replace the power board.	
The fan motor makes unusual noises	The fan motor is damaged.	Replace the fan.	

The above points are the assessment and verification of common faults.

Please do not dismantle the appliance yourself to avoid danger and damage to the induction hob.

9. DISPOSAL AND RECYCLING

Important instructions for environment

Compliance with the WEEE Directive and disposal of waste equipment:

This product complies with the EU WEEE Directive (2012/19/EU). This product bears a classification symbol for waste electrical and electronic equipment (WEEE).

This symbol indicates that this product must not be disposed of with other household waste at the end of its useful life. The used appliance must be taken to an official collection point for the recycling of electrical and electronic equipment. To find these collection points, please contact your local authorities or the retailer where you purchased the product.



Every household plays an important role in the recovery and recycling of old appliances.



Proper disposal of old appliances helps to prevent possible negative consequences for the environment and human health.

Compliance with RoHS Directive

The product you have purchased complies with the EU RoHS Directive (2011/65/EU). It does not contain any harmful and prohibited materials listed in the directive.

Package information

The packaging materials of the product are made of recyclable materials in accordance with our national environmental regulations. Do not dispose of the packaging material together with household waste or other waste. Take them to the collection points for packaging materials designated by the local authorities.



Table. 5a Regulation (EU) No 66/2014

Information for domestic electric hobs			
	Symbol	Value	Unit
Model identification		G16432B5CE	
Type of hob		Built-in hob	
Number of cooking zones and/or areas		1 area / 2 zones	
Heating technology (induction cooking zones and cooking areas, radiant cooking zones, solid plates)		Induction cooking zones/area	
For circular cooking zones or area: diameter of useful surface area per electric heated cooking zone, rounded to the nearest 5 mm	∅	zone 1:14.5 zone 2:21.0	cm
For non-circular cooking zones or areas: length and width of useful surface area per electric heated cooking zone or area, rounded to the nearest 5 mm	L W	Area 1:38.0*21.0	cm
Energy consumption per cooking zone or area calculated per kg	EC _{electric cooking}	zone 1:180.6 zone 2:181.3 Area 1:170.8	Wh/kg
Energy consumption for the hob calculated per kg	EC _{electric hob}	177.6	Wh/kg

gorenje

CE