

LUSTAR

LED TV

MODEL: 28LE17

MANUAL DE INSTRUCȚIUNI





Aparatele electrice uzate sunt materiale valoroase, motiv pentru care locul lor nu este la gunoiul menajer! Din aceasta cauză, vă rugăm să ne susțineți și să participați la protejarea resurselor naturale și a mediului înconjurător, prin predarea acestui aparat la centrele de prelucrare a acestora, în cazul în care ele există.

Fabricat în China

Manual de utilizare

Va rugam cititi cu atentie acest manual inainte de instalarea si utilizarea televizorului.

Pastrati manualul la indemana pentru referinte viitoare.

| |
|--|
|  AVERTIZARE  Nu exista atasat piese de schimb pentru întreținere. Nu deschideți capacul din spate pentru a evita un șoc electric. Vă rugăm să contactați personalul nostru de servicii post-vânzare, dacă este necesar. |
|--|

Atenție: Nu deschideți capacul din spate pentru a evita un șoc electric Nu sunt piese de schimb suplimentare în interiorul carcasei. În cazul în care aveți întrebări, vă rugăm să contactați personalul nostru de service.

 Simbolul fulger cu varf de sageata este destinat a alerta utilizatorul de prezenta unei tensiuni periculoase ce poate constitui un risc de electrocutare.

 Semnul de exclamare intr-un triunghi echilateral este destinat a va atentiona ca exista parti care sunt foarte importante. Daca este necesara inlocuirea de piese, adresati-va personalului de service calificat.

Atentie: Nu puneti televizorul în locuri ploioase sau ceată pentru a preveni de la incendiu sau electrocutare. Nu aplicati obiecte dure si nu loviti ecranul cu cristale lichide, deoarece se pot provoca zgârieturi sau daune.

Atentie: Modificarea produsului fara autorizare este interzisa.

NOTA: Presiunea excesiva a sunetului de la casti poate duce la pierderea auzului.

SIGURANTA

Vă rugăm să scoateți imediat din priza de alimentare în cazul în care există un sunet anormal sau un miros sau televizorul are sunet dar nu are imagine, și contactați service-ul autorizat



TV ar trebui să fie ferit de ploaie, umezeală și praf pentru a preveni electrocutarea și scurtcircuitul.

Nu acoperiți orificiile de aerisire cu haine de masa, perdele, ziare etc



TV trebuie să fie păstrat departe de obiecte cu temperaturi ridicate sau de lumina solară directă. Necesită o bună ventilație.

Permiteți 10 cm între televizor și alte aparate sau carcase încorporate în pereti



Puteți curăța panoul de afișaj cu o cârpă moale și curată numai după scoaterea cablului de alimentare din priză. Nu ștergeți în mod repetat ecranul sau rama, nu atingeți sau loviți ecranul cu un obiect dur.



Nu ștergeți TV cu benzina, solvenți chimici sau pe baza de alcool, deoarece va duce la deteriorarea produsului a panoului și a carcasei.



Nu așezați produsul pe o suprafață instabilă.

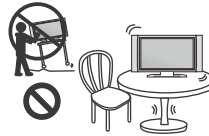

Nu așezați cablul de alimentare sau alte cabluri pe locul unde circulați pentru a nu va împiedica sau calca pe acesta. Nu supraîncălcați cablul de alimentare sau prize.



Nu se va demonta capacul din spate, deoarece există tensiuni în interior și va provoca șoc electric. Ajustările interne și verificări trebuie să fie efectuate numai de către profesioniști calificați.



Nu plasați surse de flacără deschisă, precum lumânările, pe sau în apropierea televizorului.

Vă rugăm să tragi ștecherul din priză și contactați post-vânzare, dacă există obiecte anormale sau de apă în televizor.



Scoateți cablul de alimentare și cablul de antenă în timpul furtunilor cu descărcări electrice, astfel televizorul nu este afectat de supratensiuni electrice. Păstrați toate persoanele departe de cablul de antenă în timpul furtunilor cu descărcări electrice.



ACCESORII

Vă rugăm să asigurați-vă că următoarele elemente sunt incluse cu televizorul. Dacă unul dintre ele lipsește, contactați distribuitorul.



Telecomanda

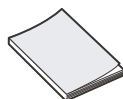

Manual de utilizare



Certificat de garantie

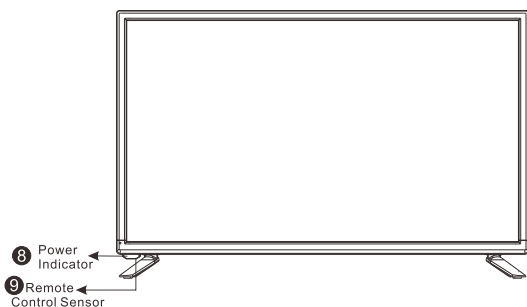

- 8 Power Indicator
- 9 Remote Control Sensor

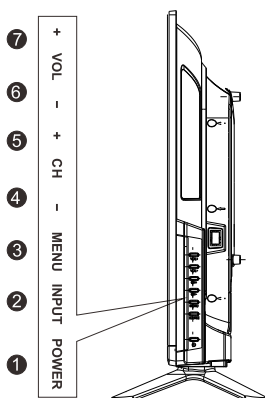

- 7 + VOL -
- 6 - VOL +
- 5 + CH -
- 4 - CH +
- 3 MENU
- 2 INPUT
- 1 POWER

PANOUL DE CONTROL

1 POWER

Porniți televizorul sau intra în modul Standby(asteptare)

2 INPUT

Buton selecție sursa semnal

3 MENU

Intra / Ieși din meniul principal.

4 CH-

Tasta Scadere Canal; scade numărul canalului și selectează ultima opțiune din meniu

5 CH+

Tasta Creștere Canal; Crește numărul canalului și selectează următoarea opțiune din meniu

6 VOL-

Tasta Scadere Volum; intra în următorul meniu și ajustează opțiunile OSD (în scădere).

7 VOL+

Tasta Creșterea volumului; intra în următorul meniu și ajustează opțiunile OSD (în creștere)

8 Senzor telecomandă

9 Indicator Pornit / Standby

CONECTAREA CABLURILOR

Acest TV LED poate fi conectat la dispozitive externe multiple. Urmatoarea diagrama prezinta conexiunile ce se pot realiza cu alte unitati video sau audio

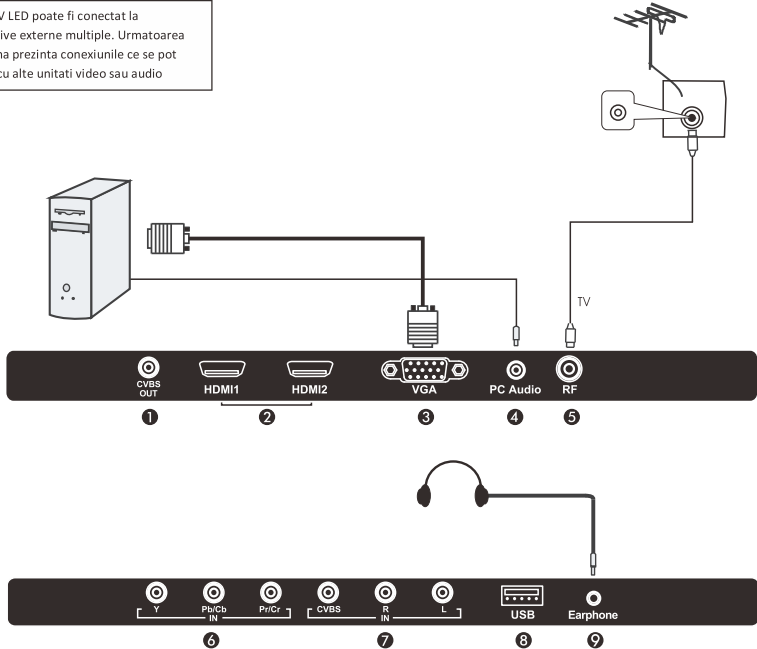

1. CVBS OUT: Acest lucru poate fi conectat la intrarea RCA a oricarei surse video

2. HDMI: interfață multimedia de înaltă definiție.

Notă: Semnal Video acceptat 480P/578P/720P/1080i/1080 P.

3. VGA: Poate fi conectat cu un cablu de semnal cu 15 pini la calculatorul dumneavoastra

4. PC audio: Intrare audio PC.

5. RF: terminalul TV.

6. Y Pb / Cb Pr / Cr: terminal de intrare Component.

7. CVBS IN: Acest lucru poate fi conectat la iesirea RCA a oricarei surse video.

AUDIO-L: Intrare audio stânga (conexiune RCA)

AUDIO-R: Intrare audio dreapta (conexiune RCA).

8. USB: Utilizatorul poate accesa fișiere multimedia stocate pe dispozitivul USB.

Poate fi utilizat si pentru actualizarea software-ului TV, dar numai de către un tehnician calificat TV.

9. Cască: Intrare pentru căști.

DESCRIEREA TELECOMENZII

Modul TV:

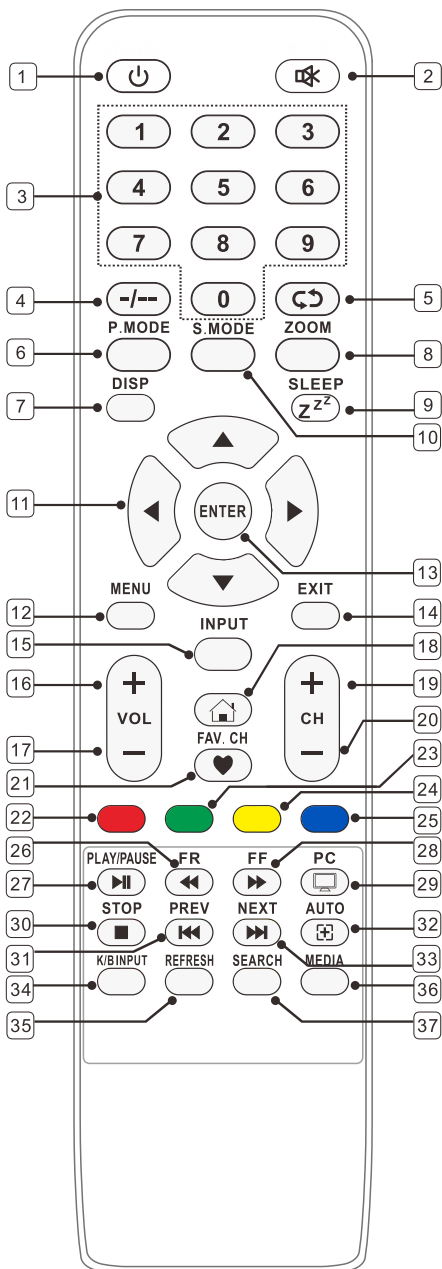

1. POWER/ALIMENTARE (): Pornește sau oprește televizorul.
2. MUTE/FĂRĂ SUNET : Dezactivați sunetul și porniți atunci când apăsați din nou
3. NUMBER BUTTONS/BUTOANELE NUMERICE: Apăsați 0-9 pentru a selecta direct canalul de televiziune în timp ce priviți televizorul.
4. „, / - / - / - ”: Setează numărul canalului de la 10 la 10+
5. Recall (): Reîntoarce la canalul precedent.
6. P.MODE: Schimbă regimurile presetate a ecranului.
7. DISP: Afisează informațiile de stare a sistemului
8. ZOOM: Mărește sau micșorează imaginea curentă
9. SLEEP/ADORMIRE: Arată timer-ul de adormire, după care televizorul se va opri automat.
10. S.MODE: Schimbă regimurile presetate a sunetului.
11. Săgețile (◀ / ▶ / ▲ / ▼): Folosiți 4 săgeți pentru a evidenția diferite puncte a meniului din televizor sau pentru a schimba valoarea.
12. MENU/MENIU: Accesează meniul principal, sau revine la nivelul de mai sus a unui submeniu.
13. ENTER: Buton de acces și confirmare.
14. EXIT/IEȘIRE: Ieșire din opțiune sau din meniul curent.
15. INPUT: Selectarea unei surse de semnal
16. VOL+: Crește volumul sunetului televizorului
17. VOL-: Reduce volumul sunetului televizorului
18. Home Key: Cheie acasă (optional)
19. CH ▲ : Mariti programul
20. CH ▼ : Reduceti programul
21. FAV CH: Apasati pentru a comuta canalele preferate în meniul TV
22. RED: Se folosește pentru funcții adiționale în meniul OSD (optional)
23. GREEN: Se folosește pentru funcții adiționale în meniul OSD (optional)
24. YELLOW: Se folosește pentru funcții adiționale în meniul OSD (optional)
25. BLUE: Se folosește pentru funcții adiționale în meniul OSD (optional)
26. Inversare rapidă
27. Derulare sau Pauza
28. Derulare rapidă înainte
29. Selectează modul PC direct
30. Oprește rula
31. Trece la capitoul anterior
32. Adaptează automat imaginea în modul PC
33. Trece la capitoul următor
34. Keyboard intrare (optional)
35. REFRESH: Reimprospăta (optional)
36. MEDIA: Selectează modul media direct
37. SEARCH: Butonul de căutare

Nota: Asigurați-vă ca telecomanda este orientată către receptorul de semnal infraroșu și aveți grijă să nu existe obstacole între raza de acțiune a telecomenzii și televizor. Distanța de operare normală va fi scurtată dacă interferează cu lumina directă a soarelui sau a unei lampi. Utilizați telecomanda cu atenție, aveți grijă să nu fie lovită sau deteriorată în vreun fel, sau să curgă lichid pe aceasta.

Instalarea bateriilor în telecomandă

1. Întoarceți telecomanda cu partea de jos în sus. Scoateți capacul compartimentului bateriilor.
2. Instalați două baterii noi AAA 1.5V, asigurați-vă că anodul și catodul bateriilor se potrivește cu semnele – și + din interiorul compartimentului pentru baterii. Dacă nu, telecomanda va fi deteriorată.

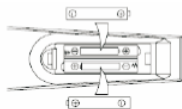

3. Închideți capacul compartimentului bateriilor.

Nota: Bateriile nu trebuie expuse la căldură excesivă, cum ar fi lumina soarelui, flacăra sau ceva similar.

CONECTAREA ANTENEI

Vă recomandăm să folosiți un cablu coaxial 75 Ω, astfel încât să elimineți tulburarea cauzată de impedanță nepotrivită. Cablul de antenă nu trebuie să fie grupat împreună cu cablul de alimentare.

Introduceți direct mufa cablului coaxial de 75 Ω în mufa de antenă atunci când se aplică televiziune prin cablu.

Notă: Antena trebuie să fie verificată periodic. Dacă imaginea nu este clară, opriți alimentarea televizorului și apoi verificați cu atenție antena pentru a fi conformă.

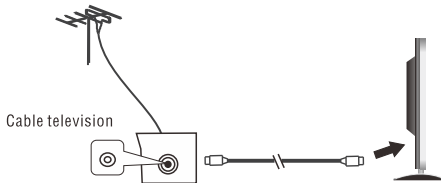

Televizor pornit/Televizor oprit

Televizorul este în standby când atunci când nu apar imagini și lampa de avertizare stralucește roșu.

Apăsați butonul de pornire de pe telecomandă și lampa indicatoare devine verde, iar apoi imaginea va apărea pe ecran.

Apăsați din nou butonul de pornire de pe telecomandă sau televizorul și televizorul va intra în starea de așteptare (standby).

Modul economisire și modul protecție

În modul video sau modul PC, televizorul va intra în starea de consum redus (standby) pentru a economisi energia și a proteja dacă timp de câteva minute nu există semnal.

VIZIONAREA PROGRAMELOR TV

Conectați cablul de alimentare, apăsați butonul POWER de pe televizor, apoi apăsați butonul INPUT pentru a selecta modul TV și a putea viziona programe TV.

Selectați canalele cu ajutorul tastelor numerice.

1. Dacă vreți să selectați un program de la 0-9, apăsați direct tastele numerice pentru a introduce numărul programului și va intra direct în programul selectat (ex: selectați programul nr 1)

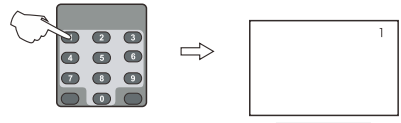

2. Dacă vreți să selectați un program de la 10-99, apăsați direct tastele numerice pentru a introduce numărul programului și va intra direct în programul selectat (ex: selectați programul nr 12)

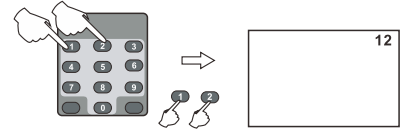

3. Dacă vreți să selectați un program de la 100-100+, apăsați direct tastele numerice pentru a introduce numărul programului și va intra direct în programul selectat (ex: selectați programul nr 100)

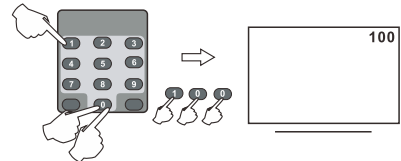

Selectare canal

1. Utilizați butoanele de pe tv pentru a efectua selectarea canalului. În primul rând apăsați butoanele "CH + / -" pentru a intra în modul de selectare a canalelor, apoi apăsați butoanele "CH + / -" pentru a selecta canalul.

2. Butoanele "CH + / -" de pe telecomandă pot fi de asemenea utilizate pentru a efectua selectarea canalului



Revenirea la canal
 Apasa butonul RECALL pentru a reveni la programul anterior.

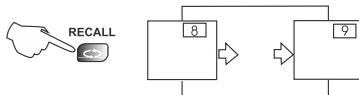

Controlul volumului

1. Folosiți butoanele "VOL + / VOL-" de pe panoul tv pentru a controla volumul.
2. De asemenea, butoanele "VOL + / VOL-" de pe telecomanda pot fi solosite pentru a controla volumul.

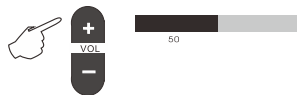

Eliminarea sunetului

Apasa butonul "MUTE" pentru a elimina sunetul. Apasa inca o data butonul sau apasa butonul de control volum pentru a reda sunetul din nou.

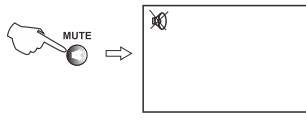

Afisare stare sistem

Apasati butonul "DISPLAY" de pe telecomanda, atunci se va afișa numarul programului actual, modul de intrare curent și informatii relevante.

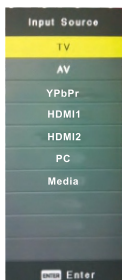
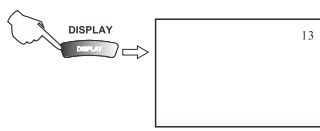

Descrierea Meniului TV

Selectarea sursei de intrare (Input Source)

Apasa INPUT pentru a afisa lista surselor.

Apasa ▼ / ▲ pentru a evidentia sursa de intrare și apoi apasa ENTER pentru a confirma.

Apasa EXIT pentru a ascunde meniul de pe ecran sau acesta va disparea dupa cateva secunde.

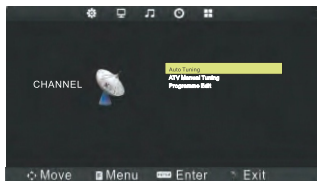

Meniu Canal

Notă: Canalul meniul este disponibil doar în modul TV, iar elementul este implicat la apăsarea MENU, dacă vrei să vizualizezi meniul Imagine / Sunet / Timp / Opțiuni, apasa ◀▶ pentru a selecta.

Cautare automata (Auto Tuning)

Auto Tuning va cauta automat canalele disponibile și canalele receptionate.

Apasa ▼ / ▲ pentru a selecta Auto Tuning, apoi apasa ENTER pentru a incepe cautarea automata.

Daca vrei sa opresti cautarea, apasa MENU sau EXIT și apasa ◀ pentru a confirma sau ▶ pentru a anula.

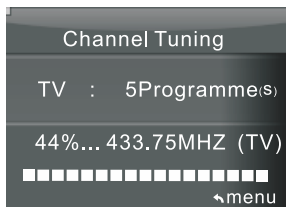

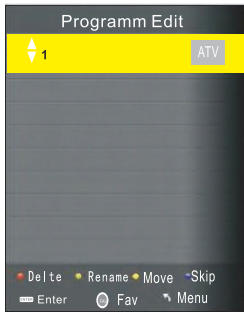

Editarea Programelor (Program Edit)

Cele patru taste colorate sunt scurtaturi pentru a programa canalele.

Intai apasa **▼ / ▲** pentru a evidentia canalul pe care vrei sa il stergi, redenumesti, muti sau sari, apoi:

Apasa butonul Rosu pentru a sterge canalul. Apasa butonul Verde pentru a intra in modul de redenumire, apoi apasa **◀/▶** pentru a alege cuvantul pe care vrei sa-l modifici si **▼ / ▲** pentru a selecta cuvantul.

Apasa butonul Galben pentru a trece canalul in modul de mutare, apoi apasa **▼ / ▲** pentru a-l muta in pozitia unde vrei sa-l asezi.

Apasa butonul Albastru pentru a sari canalul selectat. (Televizorul va sari canalul automat cand folositi tastele P+/- pentru a vedea canalele).

FAV adauga sau sterge canalul din lista de canale favorite.

Meniul Imagine(PICTURE)

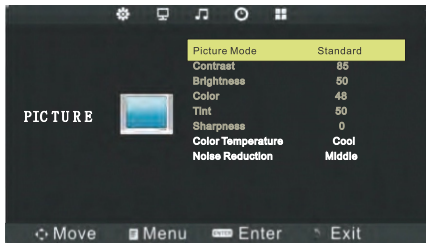

Apasa MENU pentru a afisa meniul principal si apasa **◀/▶** pentru a selecta meniul imagine(Picture)

Mod Imagine (Picture Mode)

Evidentiaza elementul si apasa ENTER sau **◀/▶** pentru a intra in sub-meniu ce va arata modurile imagine din care poti alege: Dynamic/Standard/Mild/User

Apasa PMODE de pe telecomanda pentru a selecta direct Picture Mode

Contrast /Brightness/Color/Tint (doar NTSC)/Sharpness (Contrast/Luminozitate/Culoare/Nuanta/Claritate)

Evidentiaza elementul si apasati **▶** si o bara de proces apare, apoi apasati **◀/▶** pentru a ajusta valoarea. Apasa MENU sau EXIT pentru a ascunde meniul de pe ecran.

Nota: Aceste setari pot fi ajustate numai in modul Imagine.

Temperatura Culoare (Color Temperature)

Selectati temperature colorii pe care o considerate confortabila.

Medium da culorii albe o nuanta neutra.

Cool da culorii albe o nuanta albastruie

Warm da culorii albe o nuanta rosietica

Reducere zgomot (Noise Reduction) Off/Low/Middle/High (Dezactivat / Scăzut / Mijlociu / Mare)

Poate clarifica semnalul de intrare prin setarea elementului dorit.

Meniu Sunet (SOUND)

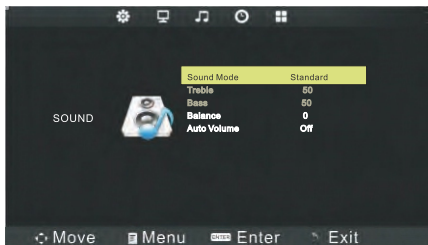

Apasa MENU pentru a afisa meniul principal, apoi apasa ◀▶ pentru a selecta meniul Sunet (SOUND).

Sound Mode(Mod sunet)

Standard/Music(Muzica)/Movie(Film)/Sports(Sport)/User(Utilizator - Numai in acest mod, Treble si Bass pot fi ajustate).

Bass – Ajusteaza sunetele de frecventa inalta.

Treble – Ajusteaza sunetele de frecventa joasa.

Balance – Ajusteaza nivelul sunetului ce vine din difuzoarele stanga si dreapta.

Auto Volume (Volum automat) Apasa L/R pentru a seta sau anula. Cand este setat pe pornit, va egala sunetul ce se aude cand exista modificari bruste in volum cum ar fi in timpul pauzelor publicitare sau schimbarea de canal.

Ajustarea Bass/Treble/balance

1. Selecteaza Sound Mode la User.
2. Evidentiaza elementul si apasa ▼ / ▲ pentru a afisa sub-meniul, apoi apasa ◀▶ pentru a ajusta valoarea.

Meniu Timp (TIME)

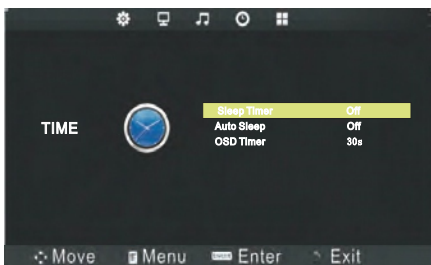

Apasa MENU pentru a afisa meniul principal, apoi apasa ◀▶ pentru a selecta meniul TIME (Timp)

Sleep Timer - Selecteaza timpul in minute (10min, 20min, 30min, 60min, 90min, 120min, 180min, 240min) dupa care vrei ca televizorul sa se stinga automat dupa ce setezi timpul. Anuleaza prin setarea la Off.

Auto Sleep - Selecteaza timpul in ore(3h,4h,5h) dupa care vrei ca televizorul sa ramana pornit dupa ultima operare. Anuleaza prin setarea la Off.

OSD Time - Selecteaza timpul in secunde(5s, 10s,15s,20s,25s, 30s,) in care vrei ca meniul de pe ecran sa ramana afisat dupa ultima operare.

Meniul Optiuni (OPTION)

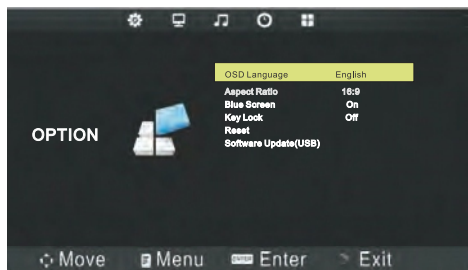

Apasa MENU pentru a afisa meniul principal, apoi apasa ◀/▶ pentru a selecta meniul OPTION

OSD Language – Seteaza limba de afisare a OSD (meniul pe ecran)

Aspect Ratio – Selecteaza ratia de aspect potrivita.

Blue Screen – Seteaza culoarea fundalului la albastru sau negru cand nu exista semnal de intrare.

Key Lock – Seteaza pentru a preveni folosirea de catre copii mici sau alti utilizatori nedoriti.

Reset – Revine la setarile implicite.

Software Update (USB) – Actualizeaza soft-ul televizorului.

Selectati software-ul din radacina dispozitivului USB si apasa ENTER apoi apasa ◀ pentru a actualiza sau ▶ pentru a anula.

Meniul Ecran (SCREEN)

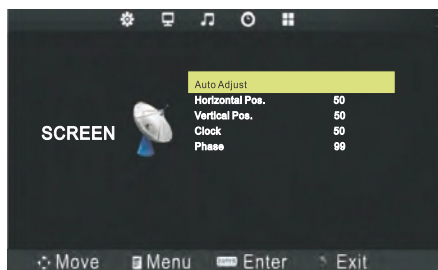

Nota: Meniul SCREEN este disponibil in modul PC. Aceste elemente sunt pentru a regal ecranul PS. Apasa ▼ / ▲ pentru a evidential una din urmatoarele optiuni, apasa ENTER sau ▶ pentru a selecta.

Auto Adjust – Ajusteaza automat setarile Clock(Ceas), Phase (faza), Horizontal Position(pozitie pe orizontala) si Vertical Position(pozitie pe verticala)

Horizontal Position – Muta ecranul in sus sau jos.

Vertical Position - Muta ecranul la stanga sau dreapta

Clock – Ajusteaza rata ceasului intern

Phase – Ajusteaza faza de semnal intern

Descrierea Meniului Media

Culoarea pictogramei arata daca televizorul a detectat un dispozitiv USB sau nu:
Albastru – Da; Gri – Nu



Apasa ◀▶ pentru a selecta PHOTO(foto)/MUSIC(muzica)/MOVIE(film)/TEXT(text) si ENTER pentru a intra in memoria USB.

Functia USB poate suporta dispozitivul USB cu memorie USB. Se pot reda fotografii, muzică, film sau fişiere text.

Format Foto suportat: JPEG, JPG, BMP, PNG.

Format Muzica suportat: WMA, MP3.

Format Film suportat: MPG,MPG4, MKV, MOV,RMVB, AVI.

Format Text suportat: TXT.

Foto (Photo)

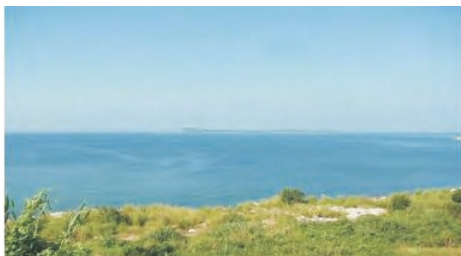

Selectati meniul si apasati ENTER pentru a vedea, vor fi afisate toate pozele din folder. Apasa ENTER pentru a afisa urmatorul meniu, apoi poti apasa pentru a selecta elementul dorit.



Apasa pentru Redare sau Stop



Apasa pentru a vedea urmatoarea poza



Apasa pentru a reda repetat toate pozele din folderul current. Apasa OK pentru a selecta modul de repetare: Repeat 1 (repeat 1)/ALL(toate)/None(niciuna)



Apasa pentru a vedea lista pozelor



Roteste in sensul acelor de ceasornic



Micsoreaza poza



Micsoreaza intai poza. Evidentiaza elementul si apasa Enter, apoi apasa ▼ / ▲ & ◀▶ pentru a muta poza.



Apasa pentru a vedea poza anterioara



Apasa pentru a opri si a te intoarce la folderol anterior



Apasa pentru a reda sau opri muzica de pe fundal



Apasa pentru a afisa informatia pozei curente (rezolutie/marime/data/timp)



Roteste in sensul invers acelor de ceasornic.



Mareste poza.

Muzica (Music)

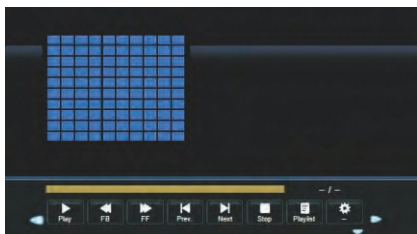

Apasa ENTER pentru a afisa meniul



Apasa pentru Redare sau Stop



Apasa pentru a derula inainte



Apasa pentru a reda urmatoarea melodie



Apasa pentru a reda repetat toate melodiile din folderul curent. Apasa ENTER pentru a selecta modul de repetare: Repeat 1(repeat 1)/ALL(toate)/None(niciuna)



Apasa pentru a vedea lista melodiilor



Apasa pentru a merge la punctul de unde vrei sa redai.



Apasa pentru a derula inapoi



Apasa pentru a reda melodia anterioara



Apasa pentru a opri si a te intoarce la interfata folderului



Apasa pentru a opri sunetul sau a reda sunetul



Apasa pentru a afisa informatia melodiei curente (rezolutie/marime/data/timp)

Film (Movie)



Apasa ENTER pentru a afisa meniul



Apasa pentru Redare sau Stop



Apasa pentru a derula inainte



Apasa pentru a reda urmatorul film



Apasa pentru a reda repetat toate filmele din folderul curent. Apasa ENTER pentru a selecta modul de repetare: Repeat 1(repeat 1)/ALL(toate)/None(niciuna)



Apasa pentru a vedea lista filmelor



Apasa pentru a reda cu incetinitorul



Apasa pentru a merge la punctul de unde vrei sa redai.



Micsoreaza dimensiunea redarii filmului



Micsoreaza intai filmul. Evidentiaza elementul si apasa Enter, apoi apasa ▼ / ▲ & ◀▶ pentru a muta poza.



Apasa pentru a derula inapoi



Apasa pentru a reda filmul anterior



Apasa pentru a opri si a te intoarce la interfata folderului



Seteaza A-B pentru a reda repetat. Apasa o data pentru a seta punctul A apoi apasa inca o data pentru a seta punctul B. Daca vrei sa anulezi, apasa a treia oara.



Apasa pentru a afisa informatia filmului curent.



Apasa pentru a reda filmul pas cu pas (cadru cu cadru)



Mareste vizualizarea filmului



Apasa pentru a schimba modul de marire.

Text

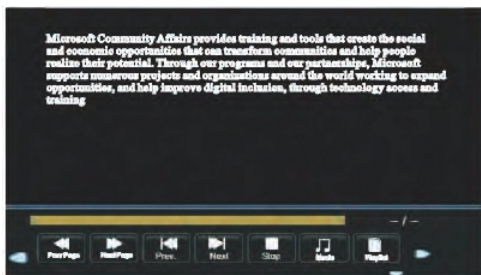

Nota: Fisierul *.txt poate fi doar detectat si citit. Apasa Enter pentru a afisa meniul



Apasa pentru a trece la pagina anterioara



Apasa pentru a trece la pagina urmatoare



Apasa pentru a trece la fisierul anterior



Apasa pentru a trece la fisierul urmator



Apasa pentru a opri si a te intoarce la interfata folderului



Apasa pentru a reda sau opri muzica de pe fundal



Apasa pentru a vizualiza lista fisierelor text



Apasa pentru a afisa informatia fisierului curent.

Specificatii

| | |
|-------------------------------|--------------------|
| Model | |
| Diagonala | 71cm |
| Putere intrare | 100-240V~ 50/60Hz |
| Putere | 45W |
| Dimensiune: baza inclusa | 639x168.8x426.2mm |
| Dimensiune: fara baza inclusa | 639x90.3x382.1mm |
| Greutate neta | Circa 3.5kg |
| Greutate bruta | Circa 4.5kg |
| Rezolutie | 1366x768 |
| System TV (RF) | PAL / SECAM |
| Sistem video | PAL / SECAM / NTSC |

Nota: Design-ul si specificatiile se pot modifica fara notificare prealabila.

Rezolvarea problemelor

Lipsa imagine sau sunet



Cauze posibile:

- *Cablul de alimentare, antena sau dispozitivele de intrare nu sunt conectate;
- *Televizorul nu este pornit.

Solutii:

- *Verificati cablul de alimentare, antena si dispozitivele de intrare;
- *Apasa tasta de pornire TV de pe telecomanda;
- *Apasa timp de 5 secunde tasta de pornire de pe televizor pentru a-l opri timp de 5 secunde

Lipsa sunet



Cauze posibile:

- *Volumul este prea mic, oprit sau anulat;
- *Sistem de sunet incorect.

Solutii:

- *Apasa tasta Volum pentru a creste volumul
- *Apasa tasta Mute pentru a anula modul Mute.
- *Schimbati sistemul de sunet din meniu

Imagine deteriorata si zgomot



Cauze posibile:

- *Cablul este deteriorat sau nu face atingere;
- *Presetare incorecta a canalului;
- *Pozitionare incorecta a antenei.

Solutii:

- *Verificati ca antena sau cablurile DVD sa fie conectate corect;
- *Resetati canalele sau reglati-le fin;
- *Ajustati directia antenei.

Culori acromatice



Cauze posibile:

- *Setari sistem culoare incorect, nivel chromatic setat scazut;
- * Pozitionare incorecta a antenei.

Solutii:

- *Schimbati sistemul de culoare din meniu, in sistemul de culoare local
- *Cresteti nivelul cromatic;
- *Ajustati directia antenei.

Telecomanda nu are efect



Cauze posibile:

- *Baterii consumate;
- *Introducerea incorecta a bateriilor;

Solutii:

- *Verificati daca bateriile snt consummate sau inlocuiti-le;
- *Verificati ca polaritatea corecta sa fie respectata

PROTECTIA MEDIULUI INCONJURATOR – DIRECTIVA 2002/96/EC

Pentru a proteja mediul inconjurator si sanatatea noastra, scoaterea din circuit a aparatelor electrice si electronice trebuie sa se faca dupa anumite reguli precise si necesita implicarea fiecaruia, fie ca este vorba de furnizor fie de utilizator. De aceea, aparatul dvs., asa



cum indica simbolul  de pe placuta, nu trebuie aruncat la cosul de gunoi, ci dus fie vanzatorului, fie depozitat in locuri special amenajate unde produsele sunt atent selectate in vederea reciclarii si refolosirii pentru alte aparate.

LUSTAR

LED TV

MODEL: 28LE17

USER MANUAL



Made in China

Table of Contents

| | |
|--------------------------------------|----------------|
| Table of Contents | UK/RO 1 / 1 |
| Warning | 2 / 27 |
| Safety | 3 / 27 |
| Accessories | 5 / 29 |
| Control panel | 6 / 29 |
| Terminal wiring Diagram | 8 / 30 |
| Remote Control | 9 / 31 |
| Antenna Preparation | 11 / 32 |
| Channel Selection | 12 / 33 |
| Channel return | 13 / 34 |
| Select Input Source | 14 / 34 |
| Channel Menu | 14 / 34 |
| Picture Menu | 15 / 35 |
| Sound Menu | 16 / 36 |
| Time Menu | 17 / 36 |
| Option Menu | 18 / 37 |
| Screen Menu | 19 / 37 |
| Media Menu | 20 / 38 |
| Specification | 25 / 42 |
| Troubleshooting | 26 / 42 |

Product introduction

1. Brief Introduction

Production Introduction

Congratulations! You have chosen the latest generation high definition liquid crystal television. Endowed with high display quality and light weight, it is power-saving and radiationless with high sensitivity television reception. The new generation liquid crystal television will bring you safe & comfortable brand new visual experience.

Applying color active matrix TFT with brand new technologies, the product can provide high quality display image, flicker free television. In addition, it can be used as definition digital television or computer display. We believe the product will surely make you satisfied.

Thank you for purchasing and using our products!

Warning

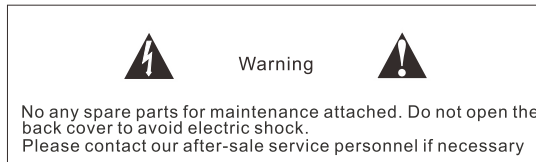

Warning: Do not open the back cover to avoid electric shock .No additional spare parts are inside the case .Any questions ,please contact our service personnel.



A triangle with a lightning arrow in:Remind you of probable higt voltage here in case of electric shock.



A triangle with an exclamation mark in :Remind you that the parts here are very important .if replacement etc.is needed,please refer to relevant technical Specifications.

Warning:Do not put the TV in rainy or foggy places to prevent from fire or electric shock.Do not apply hard objects to attrite or knock on the liquid crystal screen since these may cause scratches or damages.

Warning: Modifying the product without any authorization is forbidden.

NOTE:

excessive sound pressure from earphones and headphones can cause hearing loss.

Safety

Please immediately pull out the AC power plug from adapter if there is an abnormal sound or smell or the TV has sound but no picture, and contact after sales support.

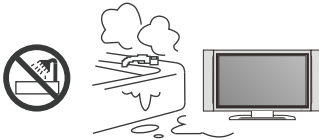

The TV should be kept free from rain, damp and dust to prevent electrical shock and short circuits. Do not cover the ventilation openings with table clothes, curtains, newspapers etc.

The TV should be kept from high temperature heating objects or direct sunlight. It requires good ventilation. Allow 10cm between the TV and other appliances or built-in cabinet walls.

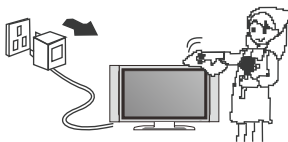
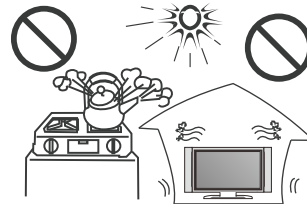

You may clean the display panel with a soft clean cloth after pulling out the power plug. Do not repeatedly wipe the panel, nor scrape, tap or strike the panel with a hard object.

Do not wipe the TV with any petrol, chemical or alcohol based solvents as it will lead to product damage of the panel and cabinet.

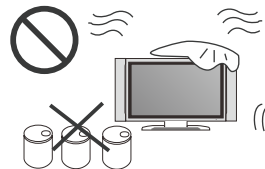

Safety

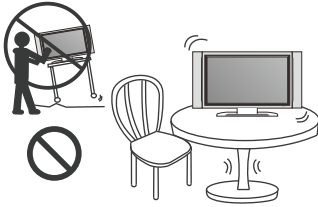

Do not place the TV on an unstable surface.

Do not place the power cord or other cables across a walkway in case it is trampled on. Do not overload the power cord or power socket.

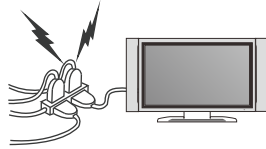

Do not disassemble the back cover as it contains high voltages inside and will cause electric shock. Internal adjustments and checks should only be conducted by qualified professionals.

Do not place naked flame sources, such as lit candles on or near the TV. Please pull out the power plug and contact after sales support if there are abnormal objects or water in the TV.

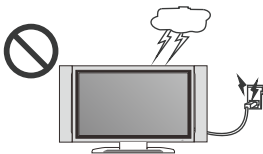
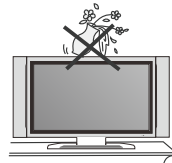

Pull out the power cord and antenna cable during electrical storms so the TV is not damaged by electrical surges. Keep all people away from the antenna cable during electrical storms.

Accessories

Please make sure the following items are included with your TV.
If any items are missing, contact your dealer.



Remote Control &
Batteries (AAx 2)

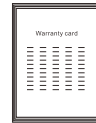
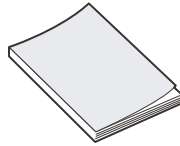

Instruction manual Warranty card

Control panel

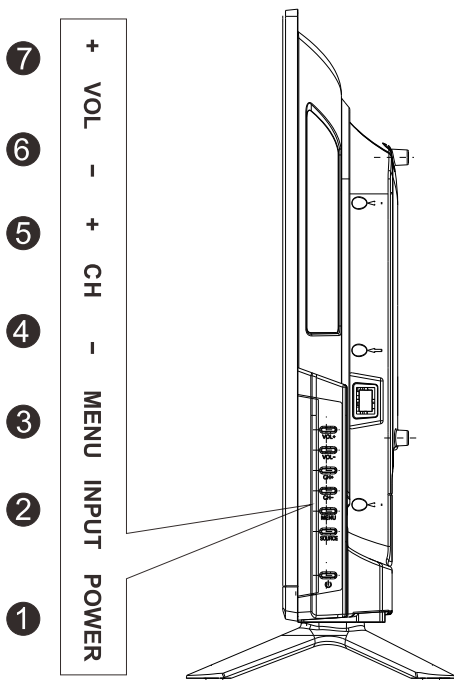
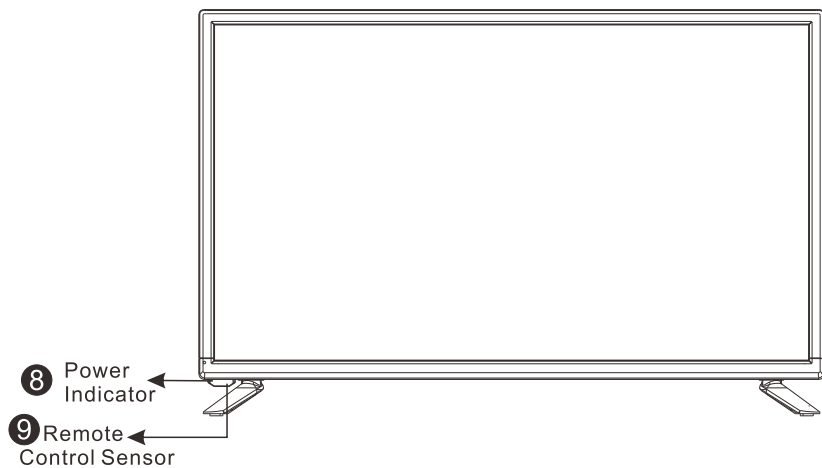

Introduction for Each Key

1 POWER

Turn the TV on or enter into standby mode.

2 INPUT

Signal source selection button.

3 MENU

Enter/exit the main menu.

4 CH-

Channel decreasing short cut key; decrease the channel No. and select the last option in the menu.

5 CH+

Channel increasing short cut key; increase the channel No. and select the next option in the menu.

6 VOL-

Volume decreasing short cut key; enter into the next menu and adjust OSD options (decreasing).

7 VOL+

Volume increasing short cut key; enter into the next menu and adjust OSD options(increasing).

8 Power/standby indicator

9 Remote control sensor

Connecting Cables

This LED TV has digital multimedia performance and can be connected to multiple external devices. The following diagram presents the connections to other video and audio appliances.

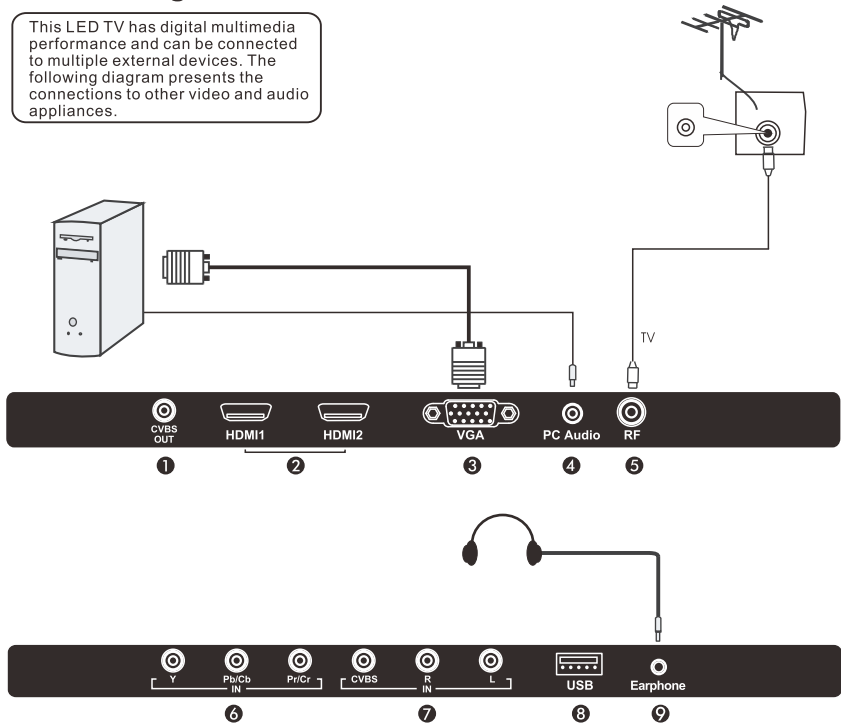







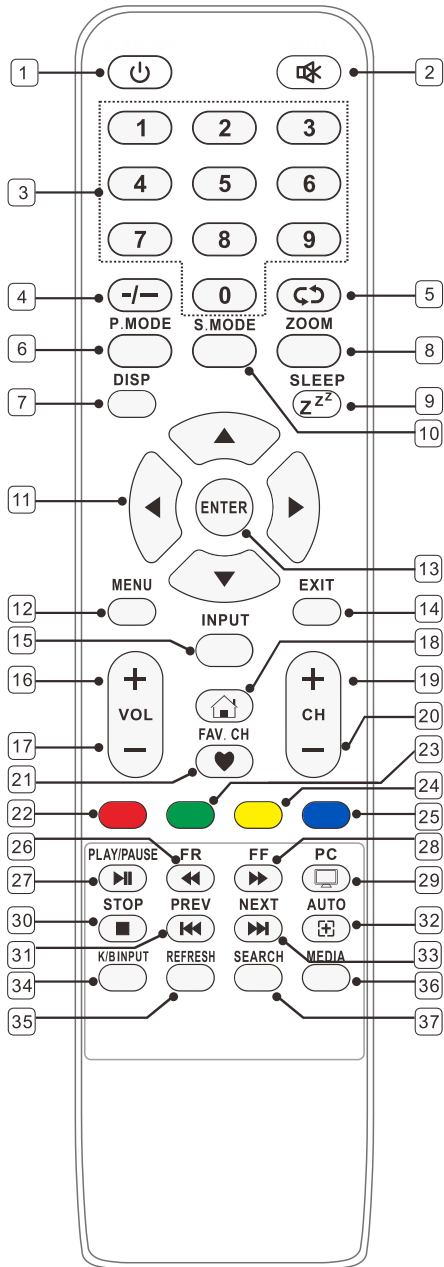



1. **CVBS OUT :** This can be connected to the RCA video in connection of any video resource.
2. **HDMI:** High-definition multimedia interface.
Note: Acceptable video signal 480P/576P/720P/1080i/1080P.
3. **VGA:** This can be connected with the D-sub 15 pin signal cable to your PC.
4. **PC AUDIO IN:** PC audio input.
5. **RF:** TV terminal.
6. **Y Pb/Cb Pr/Cr:** Component input terminal.
7. **CVBS IN:** This can be connected to the RCA video out connection of any video resource.
AUDIO-L: Left audio input (RCA connection).
AUDIO-R: Right audio input (RCA connection).
8. **USB:** User can access multi-media files stored in the USB device.
It is used to updating the software of the TV, and it should only be operated by a qualified TV technician.
9. **Earphone :** Headphone to headphones.

Remote Control

Descriptions of Television Remote Control



Descriptions of Television Remote Control

1.  : Standby turn on and off.
2.  : Mute sound.
3. 0 ~ 9: Continue to press the keys to select a channel.
4. -/---: Press this button to enter a program number for different digit. eg. -/--/-
5.  : Return to previous channel.
6. P.MODE: Select the picture mode.
7. DISP: Display the information of current video and audio.
8. ZOOM: Zoom in or out the current picture.
(Some pictures or videos may not be operated.)
9. SLEEP: Set time for TV to turn automatically.
10. S.MODE: Select the sound mode.
11.  key: The menu item selection.
12. MENU: Enter or exit menu.
13. ENTER: Confirm or enter.
14. EXIT: Exit menu or exit menu.
15. INPUT: Select the signal source.
16. VOL+: Increase the volume.
17. VOL-: Decrease the volume.
18.  : The HOME key. (Optional)
19. CH▲: Select the channel forward.
20. CH▼: Select the channel backward.
21. FAV.CH: Add Favorite.
22. RED: Access the red item or page. (Optional)
23. GREEN: Access the green item or page. (Optional)
24. YELLOW: Access the yellow item or page. (Optional)
25. BLUE: Press the blue item or page. (Optional)
26.  : Fast Backward.
27.  : Press one time to pause, press again to playback.
28.  : Fast Forward.
29. PC: Selects the PC mode directly.
30.  : Stop the playback and return to file list.
31.  : Previous.
32. AUTO: Press this button to do auto adjusting under VGA mode.
33.  : Next.
34. K/B INPUT: Keyboard INPUT. (Optional)
35. REFRESH: REFRESH. (Optional)
36. MEDIA: Selects the media mode directly. (Optional)
37. SEARCH: The SEARCH button. (Optional)

Antenna Preparation

Notes:

The remote control shall be applied in effective reception scope of the television. Make the remote control point towards the infrared receiver of the liquid crystal television and ensure that there are no obstacles. Its normal operation distance will be shortened in direct sunlight or lamplight.

Be careful to use the remote control. avoid falling off or being trampled or splashed with liquids.

Batteries In stallation of Remote-Control Unit

1. Turn the remote-control unit upside down. Scratch the grip of the battery compartment.
2. Install two new 1.5V AAA batteries, make sure the anode and cathode of the batteries matches the +, - marks inside the battery compartment. If not, the unit will be damaged.

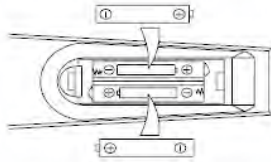

3. Close the battery compartment cover.

NOTES: Batteries shall not be exposed to excessive heat such as sunshine, fire or the like.

Antenna Connections

We recommend you use a 75 Ω coaxial cable so as to eliminate the disturbance caused by impedance mismatching. The antenna cable shall not be bundled together with the power cord.

Directly insert the 75 Ω coaxial cable plug into the antenna socket when applying cable television.

Note: The antenna should be checked periodically. If clear image is not available, shut down the power and then carefully check the antenna.

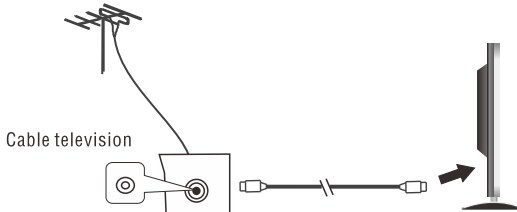

Power-on/Power-off

The television is in standby state when no images arise and the red indicating lamp shines.

Press the power button again on the remote control for the television the indicating lamp becomes green, and then television image is available.

Press the power button on the remote controller or the television to enter into standby state.

Power -saving & protection mode

1. In video or PC state, the television will enter into lower power sleep state (standby state) to conduct power saving and protection after several minutes with no signal inputs.

Channel Selection

Watching television programs

Connect the power cord, press **POWER** button to power on the television, then press the **INPUT** button to select TV channel mode to watch television programs.

Select Channels Via Program No.

1. If you want to select program no. from 0-9: directly press numeral key to input the program no., it will enter into the selected program, e.g. select program no. 1

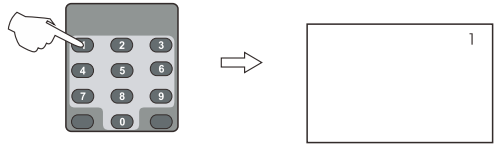

2. If you want to select program number from 10-99: Input the channel number you desired, e.g. select channel 12.

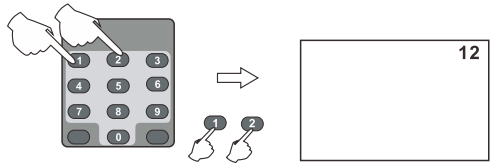

3. If you want to select program number from 100-100+: Input the channel number you desired, e.g. select channel 100.

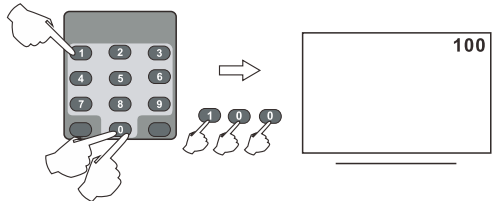

Channel select

1. Use the buttons on the television panel to conduct channel selection. First press "CH+/-" buttons on the front panel to enter into channel selection mode state, then press "CH+/-" buttons on front panel to select channel.



2. "CH+/-" buttons of the remote control may also be applied to conduct channel selection.

Channel return

Channel return

Return To Program

Press RECALL buttons to return to previous program.

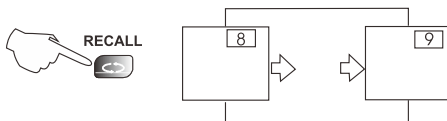

Volume control

1. Use the buttons “VOL +/VOL-” of television panel to control the volume.
2. “VOL+ /VOL- ” buttons on the remote control also manage volume control.

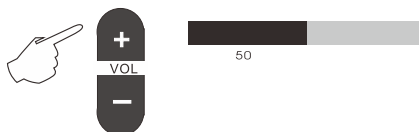

Sound elimination

Press “MUTE” button to eliminate the sound. Press the button again or press the volume control button of the television panel or the remote control for audio recovery.

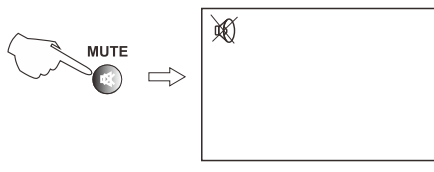

System state display

Press “DISPLAY” button of the remote control, then it will display the current program number, current input mode and information relevant.

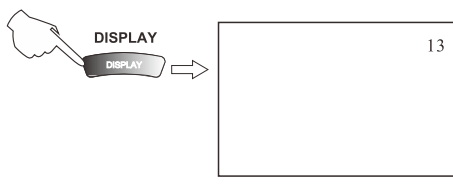

Select Input Source

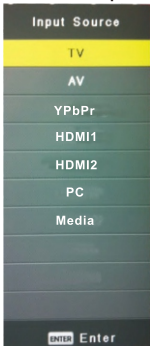

Press INPUT to display the input source list. Press ▼ / ▲ to highlight the input source and ENTER to confirm. Press EXIT to hide the On-Screen menu, or it will disappear after seconds.

Channel Menu

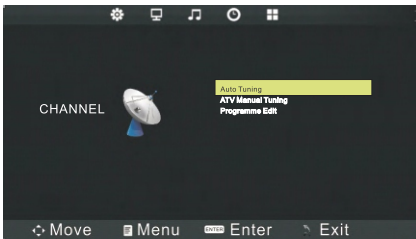

Note: The Channel Menu is available only in TV mode, and the item is the default when pressing MENU, if you want view the Picture/Sound/Time /Option Menu, please press ◀/▶ to select.

Auto Tuning

Auto Tuning will search for available channels and program receivable channels.

Press ▼/▲ to select Auto Tuning, then press OK to start auto search.

If you want to stop searching, press MENU or EXIT, and press ◀ to confirm or ▶ to cancel.

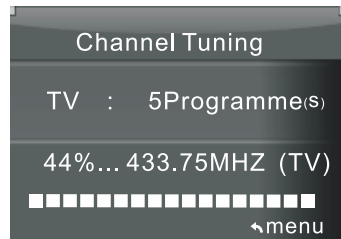

ATV Manual Tuning



Current CH Set the channel number
Color system Select the color system
Sound System Select the sound system
Fine-Turn Adjust the frequency of the channel finely.
AFC Automatic Fine tuning.
Search Press ◀ to search down from the current frequency, and press ▶ to search up.

Description of TV Menu

Programm Edit

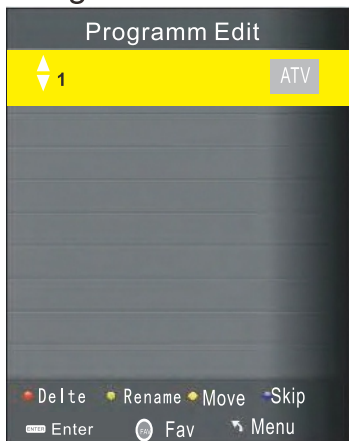

The four colored key is the shortcut key for programming the channel.

First press ∇/\blacktriangle to highlight the channel you want to delete or rename or move or skip, then:

Press the **Red** button to delete the channel.

Press the **Green** button to enter the rename state, then press $\blacktriangleleft/\blacktriangleright$ to select the word you want to change, and ∇/\blacktriangle to select word.

Press the **Yellow** button to set the channel to moving state.

then press ∇/\blacktriangle to move it to the position you want to put.

Press the **Blue** button to skip the select channel.

(Your TV set will skip the channel automatically when using CH+/- to view the channels.)

Fav Add or Delete the channel to your favorite list.

Picture Menu

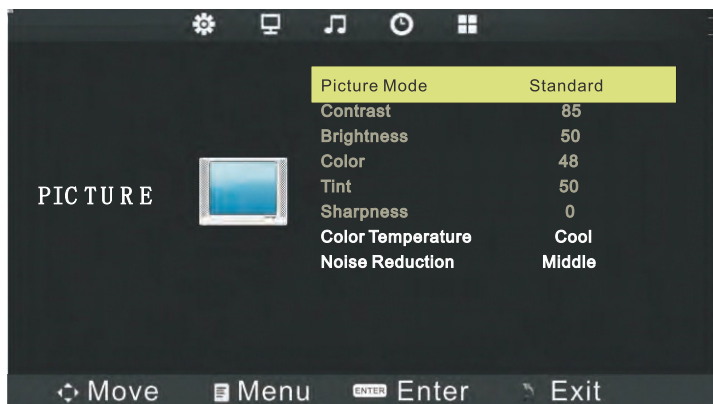

Press MENU to display the main menu, and press $\blacktriangleleft/\blacktriangleright$ to select the Picture Menu.

Picture Mode

Highlight the item and Press **OK** or $\blacktriangleleft/\blacktriangleright$ to enter the sub-menu, that shows the picture mode you can choose: Mild/Dynamic/Standard/User

Press PMODE on the remote control to select picture mode directly.

Brightness/Contrast/Color/Tint(NTSC only)/Sharpness

Highlight the item and press ►, and a process bar appears, then press ◀/▶ to adjust the value. Press MENU or EXIT to hide the on-screen menu.

Note: Those settings can be adjusted only when the Picture Mode is set to User.

Color Temperature Select the color temperature that you feel comfortable.

Medium Gives white colors a neutral tint.

Cool Gives white colors a blue tint.

Warm Gives white colors a red tint.

Noise Reduction Off/Low/Middle/High

You can clear up the input signal by set the item.

Sound Menu

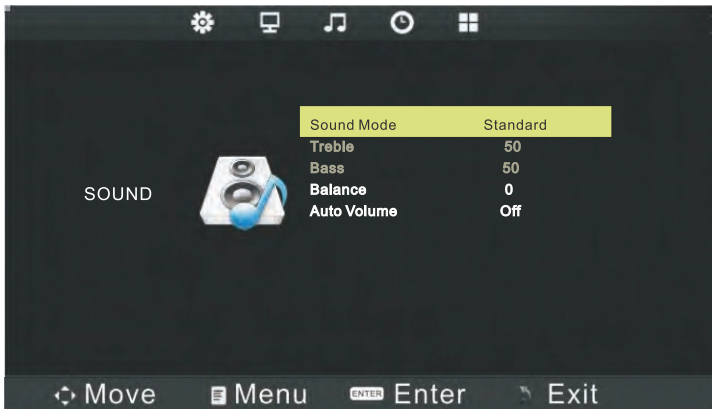

Press MENU to display the main menu, and press ◀/▶ to select the Sound Menu.

Sound Mode Standard/Music/Movie/Sports/User(Only in this mode, Treble and Bass can be adjusted).

Bass Adjust the high frequency sounds.

Treble Adjust the low frequency sounds.

Balance Adjust the level of sound coming from the left and right speakers.

Auto Volume Press L/R to set or cancel. When set on, it will level out the sound being heard when sudden changes in volume occur during commercial breaks or channel changes.

Adjusting the Bass/Treble/balance

- 1 Select Sound Mode as User.
- 2 Highlight the item and press ▼/▲ to display the sub-menu, then press ◀/▶ to adjust the value.

Time Menu

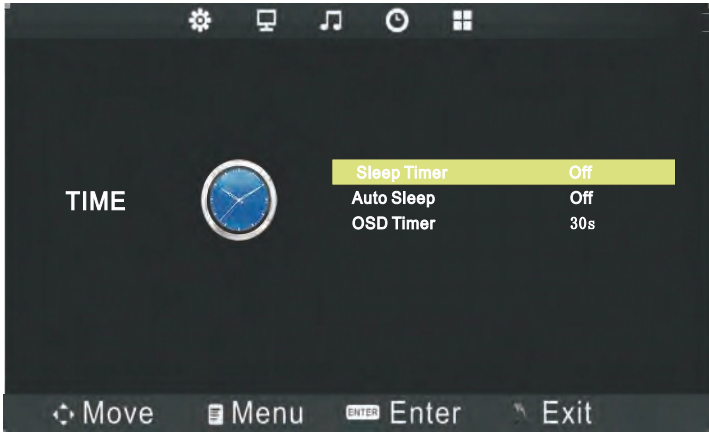

Press MENU to display the main menu, and press ◀/▶ to select the TIME menu.

Sleep Time Select the time in minutes(10min,20min,30min, 60min, 90min,120min,180min,240min) that you want the TV to shut off automatically after you set the time. Cancel by setting it to Off.

Auto Sleep Select the time in hours(3h,4h,5h) that you want the TV to remain on after your last operation. Cancel by setting it to Off.

OSD Time Select the time in seconds(5s,10s,15s,20s,25s, 30s,) that you want the On-Screen Menu remain display after your last operation.

Option Menu



Press MENU to display the main menu , and press ◀/▶ to select the OPTION menu.

OSD Language Set the OSD display language.

Aspect Ratio Select the suitable aspect Ration.

Blue Screen Set the background color to blue or black when having no input signal.

Key Lock Set to prevent it from being used by young children, or other unexpected using.

Reset Recall the default setting.

Software Update (USB) Update your TV set.

Select the software in the root of your USB memory, and press **OK**, then press ◀ to update and ▶ to cancel.

Screen Menu



Note: the Screen Menu is available in PC mode. Those items are set to adjust the pc screen. Press ▼/▲ to highlight one of the following options, then press **OK** or ► to select it

Auto Adjust Automatically adjust Clock, Phase, H-Position, and V-Position settings.

Horizontal Pos. Shift the screen up or down.

Vertical Pos. Shift the screen left or right.

Clock Adjust the internal sampling clock rate.

Phase Adjust the internal signal phase.

Media Menu

The color of the icon means whether your TV has detected a USB memory or not. Blue: Yes; Gray: No;



Press ◀/▶ to select Photo/Music/Movie/Text icon and OK to enter the USB memory.

The USB function can support the USB device with USB memory.

It can play PHOTO, MUSIC, MOVIE or TEXT files.

Photo Format Support: JPEG, JPG, BMP, PNG.

Music Format Support: WMA, MP3.

Movie Format Support: MPG, RM, RMVB, AVI, MKV, MOV.

Text Format Support: TXT.

Description of Media Menu

Photo



Select one and press **OK** to view, and it will display all the picture in the folder automatically. Press **OK** to display the following menu, then you can press to select them.



Pause

Press to play or stop.



Prev.

Press to view the previous picture.



Next

Press to view the next picture.



Stop

Press to stop and back to the previous folder.



RepeatAll

Press to play all the pictures repeatedly in the current folder. Press **OK** to select the repeat mode: Repeat 1/ALL/None



Music

Press to play or stop the background music.



Playlist

Press to view the list of pictures.



Info

Press to display the information of the current picture (Resolution/Size/Date/Time)



Rotate

Rotate clockwise.



Rotate

Rotate counterclockwise.



Zoom Out

Zoom the picture out.



Zoom In

Zoom the picture in.



Move View

Zoom out the picture first. Highlight the icon and press **OK**, then press **▼/▲&◀/▶** to move the picture.

Music

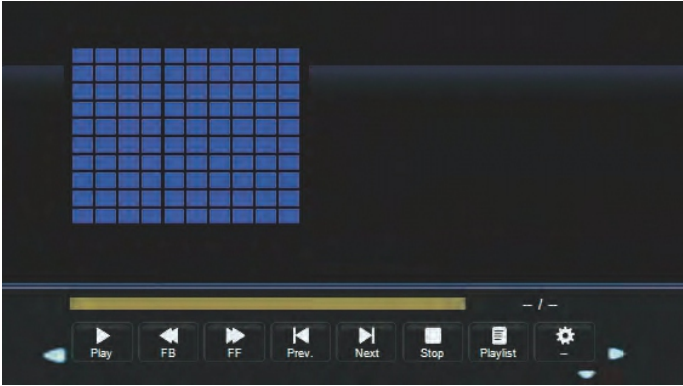

Press **OK** to display the menu.



Press to play or stop.



Press to play back faster.



Press to play forward faster.



Press to play the previous song.



Press to play the next song.



Press to stop and back to the folder interface.



Press to play all the songs repeatedly in the current folder. Press **OK** to select the repeat mode: Repeat 1/ALL/None



Press to Mute or cancel.



Press to view the list of songs.



Press to display the information of the current music (Resolution/Size/Date/Time)



Press to go the point you want to play.

Description of Media Menu

Movie

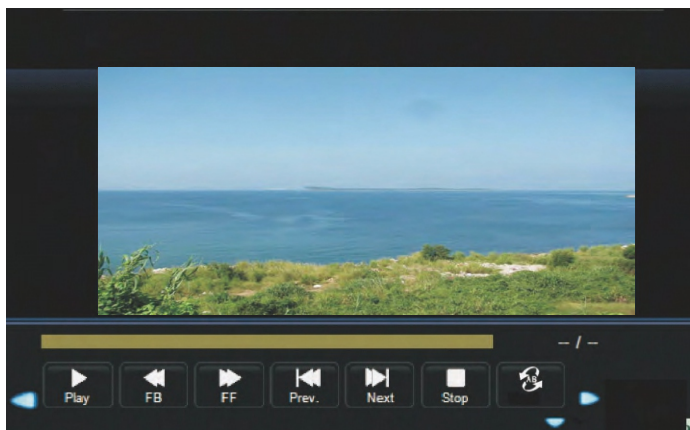

Press OK to display the menu.



Press to play or stop.



Press to play back faster.



Press to play forward faster.



Press to play the previous movie.



Press to play the next movie.



Press to stop and back to the folder interface.



Press to play all the movies repeatedly in the current folder. Press ENTER to select the repeat mode: Repeat 1/ALL/None



Set A-B to play repeatedly. Press once to set A, and press again to set B, then press the third time to cancel.



Press to view the list of movie.



Press to display the information of the current movie.



Press to play slower.



Press to play the movie step by step. (frame by frame.)



Press to go to the point you want to play.



Zoom the picture in.



Zoom the picture out.



Press to change the zoom mode.



Zoom out the picture first. Highlight the icon and press OK, then press ▼/▲&◀/▶ to move the picture.

Text

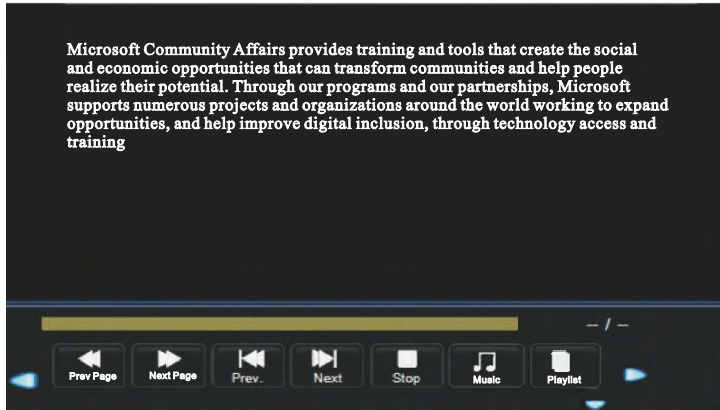

Note: The *.txt file can be detected and read only.
Press OK to display the menu.



Press to the previous page.



Press to the next page.



Press to the previous next file.



Press to the next file.



Press to stop back the folder interface.



Press to play or stop the background music.



Press to view the list of the text files.



Press to display the information of the current files.

Specification

| | |
|---|-------------------|
| Model | |
| Screen Visual images diagonal minimal size | 71cm |
| Power input | 100-240V~ 50/60Hz |
| Power | 45W |
| Size:base included | 639x168.8x426.2mm |
| Size:not include the base | 639x90.3x382.1mm |
| Net weight | About 3.5kg |
| Gross weight | About 4.5kg |
| Resolution ratio | 1366x768 |
| System TV (RF) | PAL / SECAM |
| System video | PAL / SECAM /NTSC |

Note: Design and specifications are subject to change without notice.

No image and voice



Possible causes:

- *Power cord, antenna or input devices are not connected;
- *The TV set is not powered on.

Resolutions:

- *Check Power cord, antenna and input devices;
- *Press Power key on the remote control;
- *Press Power key on the set to power it off for 5 seconds

No voice



Possible causes:

- *The volume is too low; Muted or cancelled;
- *Incorrect sound system.

Resolutions:

- *Press Volume key to turn up the volume;
- *Press Mute key to cancel Mute mode.
- *Well connect connection to the background sound;
- *Change the sound system in the menu.

Snows and noises:



Possible causes:

- *The cable is damaged or gets loose;
- *Incorrect channel preset;
- *Improper antenna positioning.

Resolutions:

- *Check whether the connection of the antenna cable, DVD and the cables is correct;
- *Reset channels or fine tune the channel;
- *Adjust the direction of the antenna.

Achromatic colour

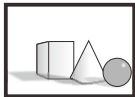

Possible causes:

- *Incorrect Colour system settings; Low chroma level setting;
- *Improper antenna positioning.

Resolutions:

- *Change the colour system into the local system in the menu;
- *Increase chroma level;
- *Adjust the direction of the antenna.

Remote control is no effect :



Possible causes:

- *Battery runs up;
- *Incorrect battery loading;

Resolutions:

- *Check the battery electricity or replace the battery;
- *Check if the poles of the battery are correct.