

















## Operating and installation instructions Freezer















To avoid the risk of accidents or damage to the appliance it is **essential** to read these instructions before it is installed and used for the first time.

# Contents

---

<b>Warnings and safety notes</b> .....	<b>5</b>
<b>Sustainability and environmental protection</b> .....	<b>14</b>
Caring for the environment .....	14
How to save energy .....	15
<b>Familiarisation</b> .....	<b>16</b>
Guide to the appliance .....	16
Start display .....	17
Settings mode  .....	18
Lock function  /  .....	18
Switching the refrigeration appliance off  .....	18
Sabbath mode  .....	18
Information on Sabbath mode <b>i</b> .....	18
Time before door alarm  is triggered .....	18
Miele@home  .....	18
Keypad tone  /  .....	19
Alarms and buzzers  /  .....	19
Display brightness  .....	19
Temperature unit °C/°F .....	19
Demo mode  .....	19
Factory defaults  .....	19
Information on the refrigeration appliance <b>i</b> .....	20
Safety .....	20
Temperature alarm .....	20
Switching the temperature alarm off early .....	20
Door alarm .....	21
Appliance functions .....	21
SuperFreeze  .....	21
<b>Commissioning</b> .....	<b>22</b>
Before using for the first time .....	22
Connecting the refrigeration appliance .....	22
Switching the refrigeration appliance on .....	22
Switching off the refrigeration appliance .....	22
To note when switching off for longer periods of time .....	22
<b>Operation</b> .....	<b>23</b>
Setting the temperature .....	23
Temperature range .....	23
Temperature display .....	23
Switching SuperFreeze  on .....	23
Switching SuperFreeze  off .....	24

Freezing and storing food .....	24
Maximum freezing capacity .....	24
Storing frozen food .....	24
Home freezing .....	24
Cooling drinks quickly .....	25
Making ice cubes .....	25
<b>Adjusting settings .....</b>	<b>26</b>
Explanation of the different settings .....	26
Switching the lock function  /  on .....	26
Switching Sabbath mode  on .....	26
Switching Sabbath mode  off .....	26
Changing the time before the door alarm  is triggered .....	27
Setting up Miele@home for the first time .....	27
Deactivating the WiFi connection .....	27
Activating the WiFi connection .....	27
Switching off the keypad tone  .....	28
Switching on the keypad tone  .....	28
Changing the volume of the alarms and buzzers  /  .....	28
Changing the display brightness  .....	28
Changing the temperature unit °C/°F .....	28
Switching off demo mode  .....	28
Resetting the settings to their factory defaults  .....	28
<b>Cleaning and care .....</b>	<b>30</b>
Cleaning agents .....	30
Preparing the refrigeration appliance for cleaning .....	30
Cleaning the inside of the appliance .....	30
Cleaning accessories by hand or in the dishwasher .....	31
Removing and dismantling accessories for cleaning .....	31
Cleaning the door seal .....	31
Cleaning the ventilation gaps .....	31
After cleaning .....	31
Defrosting .....	32
<b>Troubleshooting .....</b>	<b>33</b>
<b>Customer Service Department .....</b>	<b>40</b>
Contact in the event of a fault .....	40
EPREL database .....	40
Warranty .....	40
<b>Optional accessories .....</b>	<b>41</b>

# Contents

---

<b>Installation</b> .....	<b>42</b>
Installation site .....	42
Climate range .....	43
Ventilation.....	43
Side-by-side installation.....	44
Changing the door hinging .....	44
Furniture door panel.....	44
– Gap .....	44
Weight of the furniture door.....	45
Limiting the opening angle of the appliance door.....	45
Building-in dimensions .....	46
Niche/side view .....	46
Connections .....	48
Installing the appliance.....	49
To install the refrigeration appliance, you will need the following tools: .....	49
Preparing the refrigeration appliance.....	49
Positioning the refrigeration appliance.....	50
Aligning the refrigeration appliance.....	51
Securing the refrigeration appliance in the niche.....	52
Fitting the furniture door .....	53
Electrical connection .....	57
<b>EU Conformity declaration</b> .....	<b>58</b>
<b>UK Conformity declaration</b> .....	<b>59</b>
<b>Copyrights and licences</b> .....	<b>60</b>

## Warnings and safety notes

This refrigeration appliance complies with current safety requirements. Inappropriate use can, however, lead to personal injury and material damage.

Please read the operating and installation instructions carefully before using the refrigeration appliance for the first time. They contain important information on safety, installation, use and maintenance. This is to protect yourself from injury, and from damaging your refrigeration appliance.

In accordance with standard IEC 60335-1, Miele expressly and strongly advises that you read and follow all information provided on installing the refrigeration appliance, as well as the safety notes and warnings.

Miele cannot be held liable for injury or damage caused by non-compliance with these instructions.

Keep these operating and installation instructions in a safe place and pass them on to any future owner.

### Correct application

► This refrigeration appliance is intended for use in the home and in similar environments, for example

- in shops, offices and similar work settings
- by the guests in hotels, motels, bed & breakfasts and other typical home settings.

This refrigeration appliance is not intended for outdoor use.

► The refrigeration appliance is intended for domestic use only for storing deep-frozen food, freezing fresh food and making ice.

The refrigeration appliance is suitable for integrated under-counter installation.

Any other usage is not permitted.

## Warnings and safety notes

---

▶ This refrigeration appliance is not suitable for storing and keeping cool medicines, blood plasma, laboratory preparations or similar substances or products that are subject to the Medical Device Directive. Incorrect use of the refrigeration appliance for such purposes may cause deterioration of the items stored. The refrigeration appliance is also not suitable for use in areas where there is a risk of explosion.

Miele cannot be held liable for damage caused by improper or incorrect use or operation of the appliance.

▶ The appliance can only be used by people with reduced physical, sensory or mental capabilities, or lack of experience and knowledge, if they are supervised whilst using it, or have been shown how to use it in a safe way and recognise and understand the consequences of incorrect operation.

### Safety with children

▶ Children under 8 years of age must be kept away from the refrigeration appliance unless they are constantly supervised.

▶ Children 8 years and older may only use the appliance unsupervised if they have been shown how to use it in a safe way and recognise and understand the consequences of incorrect operation.

▶ Children must not be allowed to clean or maintain the appliance unsupervised.

▶ Please supervise children in the vicinity of the appliance and do not let them play with it.

▶ Danger of suffocation! Whilst playing, children could become entangled in packaging (such as plastic wrapping) or pull it over their head and suffocate. Keep packaging material away from children.

### Technical safety

▶ The coolant circuit has been checked for leaks. The refrigeration appliance complies with statutory safety requirements and the appropriate EU directives.



If the cooling circuit is damaged, refrigerant and oil can escape and ignite.

## Warnings and safety notes

---

▶ **Warning: fire hazard/flammable materials.** This symbol is on the compressor and indicates flammable materials. Do not remove this sticker.

The refrigerant inside the appliance (details on the data plate) is environmentally friendly but flammable.

The use of this refrigerant does, however, sometimes lead to a slight increase in the noise level of the appliance. In addition to the noise of the compressor, you might be able to hear the refrigerant flowing around the cooling circuit. Unfortunately, this cannot be avoided, but it does not affect the performance of the refrigeration appliance.

When transporting and installing the refrigeration appliance, ensure that no parts of the cooling circuit are damaged. Splashes of refrigerant can damage the eyes and leaking refrigerant can ignite.

In the event of damage:

- Avoid naked flames or anything which creates a spark.
- Disconnect the refrigeration appliance from the mains electricity supply.
- Ventilate the room where the refrigeration appliance is located for several minutes.
- Contact the Miele Customer Service Department.

▶ The more refrigerant there is in a refrigeration appliance, the larger the room it should be installed in. In the event of a leakage, if the appliance is in a small room, there is the danger of a combustible gas/air mixture building up. For every 8 g of refrigerant at least 1 m<sup>3</sup> of room space is required. The amount of refrigerant in the refrigeration appliance is stated on the data plate inside the appliance.

▶ To avoid the risk of damage to the appliance, make sure that the connection data (fuse rating, frequency and voltage) on the data plate corresponds to the household supply.

Check that this is the case before connecting the appliance. Consult a qualified electrician if in any doubt.

▶ The electrical safety of this appliance can only be guaranteed when correctly earthed. It is essential that this standard safety requirement is met. If in any doubt please have the electrical installation tested by a qualified electrician.

## Warnings and safety notes

---

► Temporary or permanent operation on an autonomous power supply system or a power supply system that is not synchronised with the mains power supply (e.g. island networks, back-up systems) is possible. A prerequisite for operation is that the power supply system complies with the specifications of EN 50160 or an equivalent standard.

The function and operation of the protective measures provided in the domestic electrical installation and in this Miele product must also be maintained in isolated operation or in operation that is not synchronised with the mains power supply, or these measures must be replaced by equivalent measures in the installation. As described, for example, in the current version of BS OHSAS 18001–2 ISO 45001.

► If the electrical connection cable supplied is damaged, it must only be replaced by an original spare part to prevent a hazard for the user. Miele can only guarantee the safety of the appliance when original Miele spare parts are used. For safety reasons, such replacement may only be carried out by a qualified specialist or the Miele Customer Service Department.

► Do not connect the appliance to the mains electrical supply by a multi-socket adapter or extension lead. These are a fire hazard and do not guarantee the required safety of the appliance.

► If moisture gets into electrical components or into the mains connection cable, it could cause a short circuit. Therefore, do not operate this refrigeration appliance in areas which are exposed to moisture (e.g. in a garage or utility room).

► This appliance must not be used in a non-stationary location (e.g. on a ship).

► Do not use a damaged appliance. It could be dangerous. Check the appliance for visible signs of damage.

► For safety reasons, this appliance may only be used after it has been built in.

► The appliance must be isolated from the electricity supply during installation, maintenance and repair work.

► Unauthorised installation, maintenance and repairs can cause considerable danger for the user.

Installation, maintenance and repairs must only be carried out by a Miele authorised technician.

- ▶ While the appliance is under warranty, repairs should only be undertaken by a Miele authorised service technician. Otherwise the warranty is invalidated.
- ▶ Faulty components must only be replaced with genuine Miele original spare parts. Miele can only guarantee the safety standards of the appliance when Miele replacement parts are used.
- ▶ This refrigeration appliance is supplied with a special lamp to cope with particular conditions (e.g. temperature, moisture, chemical resistance, abrasion resistance and vibration). This lamp must only be used for the purpose for which it is intended. The lamp is not suitable for room lighting. Replacement lamps may only be fitted by a Miele authorised technician or by the Miele Customer Service Department. This refrigeration appliance contains several light sources with at least energy efficiency class G.

### Proper installation

- ▶ When installing the refrigeration appliance, it is a mandatory requirement to follow the installation instructions supplied with it.
- ▶ Always wear protective gloves when transporting and installing the refrigeration appliance.
- ▶ Two people are required to install the refrigeration appliance.
- ▶ Change the door hinging (if necessary) as described in the installation instructions supplied with the appliance.

### Correct use

- ▶ This refrigeration appliance is designed for use within specific ambient temperatures (climate range). Do not use in ambient temperatures for which it is not designed. The climate range is stated on the data plate in the interior cabinet of the refrigeration appliance. A lower ambient temperature will cause the compressor to switch off for longer periods, meaning that the refrigeration appliance is unable to maintain the required temperature.
- ▶ Do not cover or block the air vents as this could impair the efficiency of the appliance, increase the electricity consumption and could cause damage to the components.
- ▶ If storing food which contains a lot of fat or oil in the appliance or the door, make sure that it does not come into contact with plastic components as this could cause stress cracks or break the plastic.

## Warnings and safety notes

---

- ▶ Risk of fire and explosion. Do not store explosive materials in the refrigeration appliance or any products containing propellants (e.g. spray cans). Electrical components can cause flammable mixes of gases to ignite.
- ▶ Danger of explosion. Do not operate any electrical equipment (e.g. an electric ice-cream maker) inside the refrigeration appliance.  
Danger of sparking and explosion.
- ▶ Danger of injury and damage to the appliance. Do not store cans or bottles containing carbonated drinks or liquids which could freeze in the freezer zone. Otherwise they could burst.
- ▶ Danger of injury and damage to the appliance. When cooling drinks quickly in the freezer zone, make sure bottles are not left in for more than one hour. Otherwise they could burst.
- ▶ Danger of injury. Never handle frozen food or the metal parts of the appliance with wet hands. Your hands may freeze to the frozen food or to the metal.
- ▶ Danger of injury. Do not take ice cubes out with your bare hands and never place ice cubes or ice lollies in your mouth straight from the freezer zone. The very low temperature of the frozen food can cause frost burn to the lips and tongue.
- ▶ Do not refreeze partially or fully defrosted food. Consume defrosted food as soon as possible, as it will lose its nutritional value and spoil if left for too long. Defrosted food may only be re-frozen after it has been cooked.
- ▶ Observe the manufacturer's "use-by" dates and storage instructions given on food to avoid the risk of food poisoning. Storage times will depend on several factors, including the freshness and quality of the food, as well as the temperature at which it is stored.

## Accessories and spare parts

- ▶ Only use original Miele accessories. If other parts are used, warranty, performance and product liability claims will be invalidated.
- ▶ Miele will guarantee to supply functional spare parts for a minimum of 10 years and up to 15 years following the discontinuation of your refrigeration appliance.

## Cleaning and care

- ▶ Do not use any oils or grease on the door seals, as these will cause the seals to deteriorate and become porous with time.

## Warnings and safety notes

---

- ▶ Do not use a steam cleaning appliance to clean or defrost this appliance.  
Steam could reach electrical components and cause a short circuit.
- ▶ **WARNING! DANGER of injury and damage!** Do not use any mechanical or other types of aids which are not recommended by the manufacturer to accelerate the defrosting process.
- ▶ Sharp edged or pointed objects will damage the evaporator, causing irreversible damage to the appliance. Do not use sharp edged or pointed objects to
  - remove frost and ice,
  - separate frozen food or remove ice trays.
- ▶ Do not place electric heaters or candles in the appliance to defrost it. These can damage the plastic parts.
- ▶ Do not use defrosting sprays or de-icers, as they could contain substances which could damage the plastic parts or which might cause the build-up of gases and pose a danger to health.

### Transport

- ▶ Always transport the appliance in an upright position and in its original transport packaging to avoid damage in transit.
- ▶ Danger of injury and damage to the appliance. The refrigeration appliance is very heavy and must be transported by two people.

# Warnings and safety notes

---

## Disposal of your old appliance

▶ Children playing could become trapped in the appliance and could suffocate.

- Remove the appliance doors.
- Remove the drawers.
- Leave the adjustable shelves in the refrigeration appliance so children cannot climb inside.
- If your old refrigeration appliance has a door lock, destroy it. This will prevent the risk of children playing accidentally locking themselves in and endangering their lives.

▶ Risk of electric shock!

- Cut the plug off the mains connection cable.
- Cut the mains connection cable off the old appliance.

Dispose of the plug and mains connection cable separately from the old appliance.

▶ During and after disposal, make sure that the refrigeration appliance is not placed near petrol or other flammable gases and liquids.

▶ Risk of fire due to escaping oil or refrigerant!

The refrigerant and oil inside the appliance are flammable. In high enough concentrations, escaping refrigerant or oil may ignite if they come into contact with an external heat source.

During disposal, make sure that the cooling circuit is not damaged in order to prevent refrigerant and oil escaping in an uncontrolled manner (see the data plate for details of the refrigerant).

▶ Splashes of coolant can damage the eyes. Be careful not to damage any part of the pipework whilst awaiting disposal, e.g. by

- puncturing the coolant channels in the condenser,
- bending any pipework, or
- scratching the surface coating.

## Symbol on the compressor (depending on model)

This information is only relevant for recycling. There is no risk during normal operation.
--



- ▶ The oil in the compressor can be fatal if swallowed or if it penetrates the airways.

# Sustainability and environmental protection

---

## Caring for the environment

### Disposing of the packaging material

The packaging material is used for handling and protects the appliance from transport damage. The packaging material used is selected from materials which are environmentally friendly for disposal and can generally be recycled.

Recycling the packaging material reduces the use of raw materials. Use material-specific collection points for valuable materials and take advantage of return options. Your Miele dealer will take the packaging material away.

### Disposing of your old appliance

Electrical and electronic appliances contain many valuable materials. They also contain certain materials, compounds and components which were essential for their correct functioning and safety. These could be hazardous to human health and to the environment if disposed of with household waste or if handled incorrectly. Please do not, therefore, dispose of your old appliance with household waste.



Take care not to damage your refrigeration appliance before or during disposal in an authorised, environmentally friendly manner. This is to ensure that refrigerant in the cooling circuit and oil in the compressor is contained, and will not leak into the environment.

Instead, please make use of officially designated collection and disposal points to dispose of and recycle electrical and electronic appliances in your local community, with your dealer or with Miele, free of charge. By law, you are solely responsible for deleting any personal data from the old appliance prior to disposal. You are legally obliged to remove any old batteries which are not securely enclosed by the appliance and to remove any lamps without destroying them, where this is possible. These must be taken to a suitable collection point where they can be handed in free of charge. Please ensure that your old appliance poses no risk to children while being stored for disposal.

# Sustainability and environmental protection

---

## How to save energy ...

---

- Installation site** The refrigeration appliance has to cool more often at higher ambient temperatures and consumes more energy in the process. Therefore:
- Install the refrigeration appliance in a well-ventilated room.
  - Do not install the refrigeration appliance near to a heat source (heater element, cooker).
  - Protect the refrigeration appliance from direct sunlight.
  - Ensure an ideal ambient temperature of 20 °C.
  - Clean the ventilation openings on a regular basis to remove any dust.
- Temperature setting** The colder the temperature, the higher the energy consumption. The following settings are recommended:
- -18 °C in the freezer section.
- Use** Energy consumption is increased by heat input and impeded air circulation. Therefore, you should:
- Only open the appliance door(s) when necessary and for as short a time as possible. Arrange the food in such a way that makes it easy to find in the appliance.
  - Always close the appliance door(s) properly after opening them.
  - Allow hot food and drinks to cool down before placing them in the refrigeration appliance.
  - Store food well packaged or covered.
  - Do not overfill the compartments to allow air to circulate.
  - Keep drawers and shelves arranged as they were when the appliance was delivered.
  - When placing food in the appliance, make sure that the ventilation slots are not blocked.

# Familiarisation

---

## Guide to the appliance

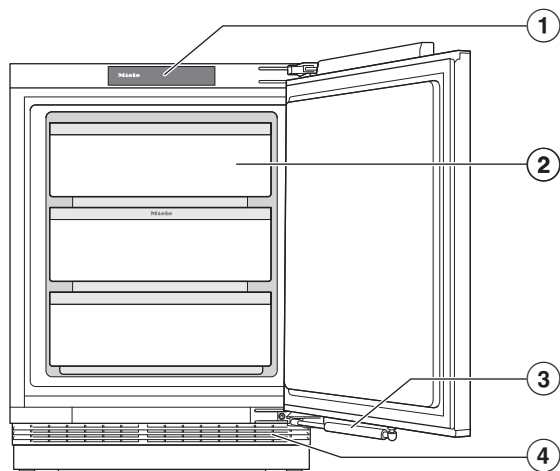

- ① Display
- ② Freezer drawer
- ③ Soft-close mechanism (SoftClose)
- ④ Ventilation grille

## Start display

The display can be scratched by pointed or sharp objects, e.g. pens.  
Only touch the display with your fingertips.  
It is possible that the display will not react to finger contact if your fingers are cold.

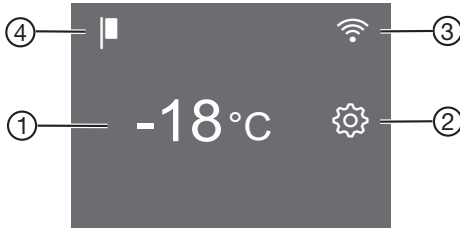

- ① Temperature display for freezer section
- ② Settings mode   
sensor control for adjusting various settings in Settings mode
- ③ Display for Miele@home connection status  
(only visible when the Miele@home function has been set up)
- ④ Demo mode display  
(only visible when the Demo mode function has been switched on)

## Operating the refrigeration appliance via the display

- Touch the area/symbol you want on the start display.
- Swipe left or right across the display until the value/symbol you want is shown in the middle.
- Tap on the option you want on the display to confirm.  
The selected value/symbol will light up orange (except for a few exceptions).
- To leave the Settings level, tap on  or *OK*.

# Familiarisation

## Settings mode

### Lock function /

When the lock function is switched on, it protects the refrigeration appliance from being switched off unintentionally and being adjusted unintentionally by unauthorised persons, e.g. children.

If you just want to quickly adjust the temperature, for example, you can deactivate the lock function temporarily (see “Adjusting settings”).

### Switching the refrigeration appliance off

See “Commissioning – Switching off the refrigeration appliance”.

### Sabbath mode

The refrigeration appliance offers a Sabbath mode for the purposes of religious observance (see “Adjusting settings”).

When Sabbath mode  is switched on, the following are deactivated temporarily:

- Interior lighting when the appliance door is opened
- All visual and audible signals
- The display
- An active WiFi connection

All other functions switched on previously remain activated.

When Sabbath mode  is switched on, you cannot make any settings on your refrigeration appliance.

### Information on Sabbath mode

You can call up the Sabbath mode version here.

### Time before door alarm is triggered

You can set the time before the appliance door alarm is triggered here (see “Adjusting settings”).

### Miele@home

Your refrigeration appliance is equipped with an integrated WiFi module.

Networking is deactivated at the factory.

Here you can set up the Miele@home function for the first time, deactivate and activate the WiFi or reset the network configuration (see “Adjusting settings”).

To use this feature, you will need:

- A WiFi network
- The Miele app
- A Miele user account. You can create a user account via the Miele app.

The Miele app will guide you as you connect your refrigeration appliance to your home WiFi network.

Once the refrigeration appliance is connected to your WiFi network, you can use the app to carry out the following activities, for example:

- Call up information on the operating status of your refrigeration appliance
- Change the settings on your refrigeration appliance

Connecting your refrigeration appliance to your WiFi network will increase energy consumption, even when the appliance is switched off.

Make sure that the signal of your WiFi network is sufficiently strong in the place where you want to set up your refrigeration appliance.

## Availability of the WiFi connection

The WiFi connection shares a frequency range with other appliances (including microwave ovens and remote control toys). This can give rise to sporadic or even complete connection failures. Therefore, the availability of featured functions cannot be guaranteed.

## Miele@home availability

The ability to use the Miele app depends on the availability of the Miele@home service in your country.

The Miele@home service is not available in every country.

For information about availability, please visit [www.miele.com](http://www.miele.com).

## Miele App

The Miele App is available to download free of charge from the Apple App Store® or from the Google Play Store™.



## Keypad tone

You can switch the keypad tone on or off here (see “Adjusting settings”).

## Alarms and buzzers

You can change the volume of the alarms and buzzers (e.g. in the event of a door alarm or a fault message) here. Alternatively, you can switch the alarms

and buzzers off completely if you find them annoying (see “Adjusting settings”).

## Display brightness

You can adjust the display brightness to the lighting conditions in the room here (see “Adjusting settings”).

## Temperature unit °C/°F

You can set the required temperature unit (°Celsius or °Fahrenheit) here (see “Adjusting settings”).

## Demo mode

You can switch off demo mode here if it has been switched on as a default setting ( will appear in the start display) (see “Adjusting settings”).

Demo mode allows the refrigeration appliance to be presented in the showroom without the cooling system being switched on. This setting is not needed for domestic use.

## Factory defaults

You can reset the refrigeration appliance’s settings to their factory defaults here (see “Adjusting settings”).

**Tip:** Reset the refrigeration appliance’s settings to the default settings when disposing of your refrigeration appliance, selling it or putting a used refrigeration appliance into operation. This will reset the network configuration so that your personal data is deleted from the refrigeration appliance. This will also ensure that a previous owner is no longer able to access the refrigeration appliance.

# Familiarisation

## Information on the refrigeration appliance

You can call up the model identifier and serial number of your refrigeration appliance here.

Keep this appliance data to hand:

- For integrating the refrigeration appliance into your WiFi network (see “Adjusting settings – Setting up Miele@home for the first time”)
- When reporting an appliance fault to the Miele Customer Service Department (see “Customer Service Department”)
- When retrieving information from the EPREL database (see “Customer Service Department”)

## Safety

### Temperature alarm

The refrigeration appliance has been fitted with a temperature alarm so that the temperature in the freezer zone cannot rise unnoticed.

If the temperature becomes too warm,  will light up red in the temperature display.

An alarm will also sound until the cause of the alarm is rectified or the alarm is switched off.

The set temperature determines when the appliance recognises a temperature as being too warm.

The audible and visual signals may be activated in the following situations:

- You switch on the refrigeration appliance and the temperature differs greatly from the set temperature.
- Too much warm ambient air enters the freezer when you are rearranging or taking out frozen food.
- You are freezing large amounts of food at once.
- You are freezing warm food.
- There was a power cut.
- The refrigeration appliance has a fault.

 Health risk caused by decomposing food.

If the temperature in the freezer remains above -18 °C for a long time, the frozen food can start to defrost. This will reduce the storage life of the food.

Check whether the frozen food has started to defrost. If it has, check that the food is safe to use and if it is, then use it as soon as possible or cook it before freezing it again.

### Switching the temperature alarm off early

Before you switch the temperature alarm off, you must determine the cause and rectify it.

If the alarm disturbs you, it can be turned off early.

■ Tap .

The alarm message is confirmed:  goes out and the alarm stops.

The start screen appears in the display: the warmest temperature recorded in the freezer section will flash for about 1 minute in the display. Then the temperature display will change to the current temperature in the freezer section.

## Door alarm

The refrigeration appliance is fitted with a door alarm to avoid increased energy consumption and food becoming warm if the door is left open.

If the appliance door is left open for an extended period,  will light up yellow in the temperature display. An alarm will also sound and the interior lighting will flash.

The amount of time until the door alarm is triggered can be changed (see “Adjusting settings – Changing the time before the door alarm is triggered”).

The door alarm’s buzzer can also be switched off (see “Adjusting settings – Changing the volume of the alarms and buzzers”).

The alarm will stop and  will go out on the display as soon as the appliance door is closed.

## Switching the door alarm off early

- Tap .

The alarm will stop,  will go out and the interior lighting will light up again constantly.

If the appliance door is not closed, the door alarm will sound again after a short time.

## Appliance functions

### SuperFreeze ❄

When switched on, the SuperFreeze function ❄ can be used to rapidly reduce the temperature in the **freezer zone** to its lowest setting (depending on the ambient temperature). The refrigeration appliance will work at full power and lower the temperature. Select this function before freezing fresh food. This helps food to freeze quickly and retain its nutrients, vitamins, flavours and appearance.

The SuperFreeze ❄ function must be switched on approx. **6 hours before the food to be frozen is placed in the freezer** (see “Operation” section, “Switching on SuperFreeze ❄”). When you are freezing the **maximum amount of food**, the SuperFreeze function ❄ should be switched on **24 hours beforehand**.

The SuperFreeze function ❄ will switch itself off automatically after a maximum of 72 hours. The quantity of fresh food placed in the freezer will determine the duration before it switches off.

# Commissioning

## Before using for the first time

- Remove all packaging material and protective film.
- Clean the inside of the appliance and the accessories (see “Cleaning and care”).

## Connecting the refrigeration appliance



- Connect the refrigeration appliance to the electricity supply as described in “Electrical connection”.

Miele will then appear on the appliance display, followed by .

## Switching the refrigeration appliance on

- Open the appliance door.
- Tap  on the display.

The refrigeration appliance will start to cool and the interior lighting will come on.

When the set temperature is reached, the   symbol disappears, the temperature display lights up constantly and the alarm tone stops.

- If the alarm annoys you, tap  .

The alarm will stop.

The refrigeration appliance will gradually reach the pre-set temperatures.

Do not place food in the freezer zone until it has reached the preset temperature (min. -18 °C).

## Switching off the refrigeration appliance

- Touch the temperature display on the display.
- Swipe right until  is shown in the middle.

- Tap .

The cooling and interior lighting are switched off.

 will appear in the display.

Please note: The refrigeration appliance is not disconnected from the power supply when it is switched off.

## To note when switching off for longer periods of time

If, during a long absence, the refrigeration appliance is switched off but not cleaned and the door is left shut, there is a danger of mould building up inside the appliance. It is essential to clean the refrigeration appliance before a long period of absence.

If the refrigeration appliance is not going to be used for a longer period of time, observe the following:

- Switch the refrigeration appliance off.
- Switch off at the wall and disconnect the plug from the socket, or disconnect the fuse.
- Clean the refrigeration appliance and leave the door ajar to air the appliance and avoid odours building up inside.

## Setting the temperature

 Health risk caused by decomposing food.

To freeze fresh food, a temperature of **-18 °C** is required. Please note that, if the temperature is any warmer, the food will have a shorter shelf life.

When freezing food and storing it over the long term, set a minimum temperature of **0 °F (-18 °C)**.

- Touch the temperature display.
- Swipe left or right until the temperature you want is shown in the middle.
- Tap the temperature you want to confirm.

The temperature display will then change back to the current temperature in the freezer zone.

By keeping the freezer zone at a constant temperature of -18 °C and taking appropriate hygiene measures you can maximise the storage life of your food and avoid food waste.

The temperature in the freezer zone increases:

- The more often the appliance door is opened and the longer it is kept open
- The more food is stored in it
- The warmer the food is which is being put into it
- The higher the ambient temperature surrounding the refrigeration appliance This refrigeration appliance is designed for use within specific ambient temperatures (climate range). Do not use in ambient temperatures for which it is not designed.

## Temperature range

The temperature in the freezer zone can be adjusted from -15 °C to -28 °C.

## Temperature display

In normal operation, the temperature display shows the current **maximum freezer section temperature** in the refrigeration appliance.

Depending on the ambient temperature and the temperature setting, it can take the appliance a few hours to reach the temperature required and for this temperature to then be shown as a constant temperature in the display.

## Switching SuperFreeze ❄️ on

The SuperFreeze function ❄️ should be switched on around **6 hours before placing food in the freezer**. If you are freezing the **maximum amount of food**, the SuperFreeze function ❄️ should be switched on **24 hours beforehand**.

You do **not** need to switch on the SuperFreeze function:

- If you are placing food that is already frozen in the freezer
- If you only freeze up to 2 kg of fresh food daily

- Touch the temperature display for the freezer zone.
- Tap ❄️.
- ❄️ will light up orange.
- Tap on the temperature display to leave the Settings level.

# Operation

## Switching SuperFreeze ❄️ off

The SuperFreeze function ❄️ will switch itself off automatically after a maximum of 72 hours.

To save energy, you can switch off the SuperFreeze function early yourself once food and drinks are sufficiently chilled.

- Touch the temperature display for the freezer zone.
- Tap ❄️.
- ❄️ no longer lights up orange.
- Tap on the temperature display to leave the Settings level.

## Freezing and storing food

### Maximum freezing capacity

To ensure that fresh food placed in the freezer freezes through to the core as quickly as possible, the maximum freezing capacity must not be exceeded. The maximum freezing capacity for freezing within a 24-hour period is given on the data plate: "Freezing capacity ... kg/24 hrs".

### Storing frozen food

- When buying frozen food to store in your freezer, check:
  - That the packaging is not damaged
  - The use-by date
  - That the temperature at which the frozen food is being stored in the shop is -18 °C or colder
- Where possible, transport frozen food in an insulated bag and then store it quickly in the refrigeration appliance.

## Home freezing

### Not suitable for freezing

Please note that some food is not suitable for freezing. This includes, for example, vegetables that are usually eaten raw, such as lettuce or radishes.

### To note before placing food in the freezer

- When freezing more than 2 kg of fresh food, switch on the SuperFreeze function ❄️ for 6 hours before placing the food in the freezer.
- When freezing even larger amounts of food, switch on the SuperFreeze function ❄️ for 24 hours before placing the food in the freezer.

This helps the frozen food which is already stored in the freezer to stay frozen.

- Only freeze fresh food which is in good condition.

**Tip:** To retain colour, taste, aroma and vitamin C, vegetables should be blanched before they are frozen. To do so, place vegetables portion by portion into boiling water for 2–3 minutes. Then remove and plunge the vegetables into ice-cold water to cool quickly. Leave the vegetables to drain.

### Packaging food for freezing

- Freeze food in portions.

**Tip:** Use suitable packaging to avoid freezer burn (such as freezer containers).

- Expel as much air as possible from the packaging and close it tightly.
- Make a note of the contents and the date of freezing on the packaging.

## Placing food in the freezer

 Risk of damage caused by loading too much food.

Loading food which is too heavy can cause damage to the freezer drawers. Do not exceed the relevant maximum load size:

Bottom freezer drawer = 10 kg  
All other freezer drawers = 15 kg.

Unfrozen food should not touch frozen food as this will cause the frozen food to begin to thaw.

- To prevent food sticking together when frozen, make sure that the packaging and containers are dry.

To ensure that food freezes through to the core quickly, do not exceed the following packaging and container sizes:

- Fruit and vegetables: max. 1 kg
- Meat: max. 2.5 kg

### – Freezing small amounts of food

- Place the food flat in the **top** freezer drawer so that it freezes through to the core as quickly as possible.
- Place the food so that it is touching the back of the drawer if possible.

### – VarioRoom: freezing large amounts of food

**Tip:** You can expand the space available in the freezer zone. If you wish to freeze large items such as a turkey or game, the top freezer drawers can be removed.

- Do not exceed the maximum permitted amount of food for freezing (see the specifications on the data plate).

If the ventilation slots are blocked, the cooling performance will decrease and energy consumption will increase.

When placing food in the freezer, make sure that the ventilation slots are not blocked.

- Distribute the food across all the freezer drawers, ideally the **top** freezer drawers.
- Place the food so that it is touching the back of the drawer to help it freeze through to the core as quickly as possible.

### After freezing

- Switch the SuperFreeze function  off.
- Place the frozen food in the freezer drawers and push them back in.

### Cooling drinks quickly

- When cooling drinks quickly in the freezer zone, make sure bottles are not left in for **more than 1 hour**. Otherwise they could burst.

### Making ice cubes

- Fill the ice cube tray 3/4 full with water and place it on the bottom of one of the freezer drawers.
- Once frozen, use a blunt instrument, for example a spoon handle, to remove the ice cube tray from the freezer if it is stuck.



**Tip:** Ice cubes can be removed easily from the tray by twisting the tray gently or by holding it under cold running water for a short time.

# Adjusting settings



## Explanation of the different settings

The door alarm and other warnings are automatically disabled when the appliance is in Settings mode .

### Switching the lock function / on

- Tap .
- Swipe left or right until  is shown in the middle.
- Tap .

When the lock function is switched on,  will light up orange.

- To leave this Settings level, tap .
- Close the appliance door. Only then will the lock function  be active.

### Deactivating the lock function / temporarily

If you want to adjust the temperature, for example, you can deactivate the lock function temporarily:





- Touch the temperature display.
- Touch  for approx. 6 seconds.

The display switches to the temperature controls.

- Now select the required settings.

Closing the appliance door will reactivate the lock function .

### Switching the lock function / off completely



- Tap .
- Touch  for approx. 6 seconds.
- Swipe left or right until  is shown in the middle.
- Tap .

When the lock function is switched off,  will light up white.

- To leave this Settings level, tap .

### Switching Sabbath mode on

When Sabbath mode  is switched on, you cannot change any settings.

- Tap .
- Swipe left or right until  is shown in the middle.
- Tap .

 will light up orange.

- To leave this Settings level, tap .

If Sabbath mode  is switched on, this is indicated on the display for approx. 3 s.





The display then switches off.

Ensure that the appliance door is properly closed, as visual and audible alarms are switched off.

### Switching Sabbath mode off

The Sabbath mode function  will switch off automatically after approx. 80 hours.





However, you can switch the Sabbath mode function  off early.

- Tap the black display.  will appear in the display.
- Tap .
-  will light up orange.
- Tap the  symbol again.



When Sabbath mode is switched off,  will light up white.

- To leave this Settings level, tap .

## Changing the time before the door alarm is triggered

- Tap .
- Swipe left or right until  is shown in the middle.
- Tap .
- Swipe left or right until the time you want between 30 seconds and 3 minutes 30 seconds is shown in the middle.
- Tap to confirm the setting.
- To leave this Settings level, tap .

## Setting up Miele@home for the first time







- Tap .
- Swipe left or right until  is shown in the middle.
- Tap .
- Tap the connection method you wish to use (app or WPS).

After you have successfully logged in,  will appear in the display.







If a connection could not be created,  will appear.

- In this case, start the process again.
- To leave this Settings level, tap .

## Deactivating the WiFi connection







- Tap .
  - Swipe left or right until  is shown in the middle.
  - Tap .
  - Tap  to deactivate the WiFi connection.
-  will appear in the display.
- To leave this Settings level, tap .

## Activating the WiFi connection

- Tap .
  - Swipe left or right until  is shown in the middle.
  - Tap .
  - Tap  to activate the WiFi connection.
-  will appear in the display.
- To leave this Settings level, tap .

When the WiFi connection is active,  will light up on the display.

## Resetting the network configuration

- Tap .
- Swipe left or right until  is shown in the middle.
- Tap .
- Swipe right until  is shown in the middle.
- Tap .
- Tap .
- To leave this Settings level, tap .

All entered settings and values for Miele@home are reset to the default settings.



The WiFi connection has been deactivated.  will go out on the start display.

Reset the network configuration if you are disposing of or selling your refrigeration appliance, or if you are putting a used refrigeration appliance into operation. All personal data is removed from the refrigeration appliance. This will also ensure that a previous owner is no longer able to access the refrigeration appliance.

# Adjusting settings

---



## Switching off the keypad tone

- Tap .
- Swipe left or right until  is shown in the middle.
- Tap .

If the keypad tone is switched off,  will light up white.

- To leave this Settings level, tap .



## Switching on the keypad tone

- Tap .
- Swipe left or right until  is shown in the middle.
- Tap .

If the keypad tone is switched on,  will light up orange.

- To leave this Settings level, tap .

## Changing the volume of the alarms and buzzers /

- Tap .
- Swipe left or right until  is shown in the middle.
- Tap .
- Select the volume you want by swiping the segment bar to the left or right (level 1–7).

■ If you want to switch the alarms and buzzers off completely, swipe to the left until the segment bar goes out completely.





- Confirm the setting you want by tapping the segment bar.

When the alarms and buzzers are switched off,  will light up white.

When the alarms and buzzers are switched on,  will light up orange.

- To leave this Settings level, tap .

## Changing the display brightness

- Tap .
- Swipe left or right until  is shown in the middle.
- Tap .
- Select the brightness you want by swiping the segment bar to the left or right (level 1–7).
- Confirm the setting you want by tapping the segment bar.
- To leave this Settings level, tap .





## Changing the temperature unit °C/°F

- Tap .
- Swipe left or right until °C or °F is shown in the middle.
- Tap °C or °F to change the temperature unit.

°C or °F will appear on the display.





- To leave this Settings level, tap .

## Switching off demo mode

- Tap .
- Tap .
- Swipe left or right until  is shown in the middle.
- Tap .

After demo mode  has been switched off, the refrigeration appliance shuts down and must be switched on again.

## Resetting the settings to their factory defaults

- Tap .
  - Swipe left or right until  is shown in the middle.
  - Tap .
-  will appear in the display.

- Tap .

The refrigeration appliance shuts down and must be switched on again.

# Cleaning and care

The data plate located inside the interior cabinet of the refrigeration appliance must not be removed. It contains information which is required in the event of a fault.

Do not let water get into the electronic unit or the lighting.

 Risk of damage due to moisture ingress.

The steam from a steam cleaner can damage plastic and electrical components.

Do not use a steam cleaner to clean the refrigeration appliance.

## Cleaning agents

Cleaning and conditioning agents used in the interior cabinet of the refrigeration appliance must be food safe.

To avoid damaging the surfaces of the appliance, **do not use the following:**

- Cleaning agents containing soda, ammonia, acids or chlorides
- Cleaning agents containing descaling agents
- Abrasive cleaning agents (e.g. scouring powder, scouring liquid or pumice stones)
- Cleaning agents containing solvents
- Stainless steel cleaners
- Dishwasher cleaner
- Oven sprays
- Glass cleaning agents
- Hard, abrasive sponges and brushes (e.g. pot scourers)
- Eraser stain remover blocks

- Sharp metal scrapers

We recommend using a clean sponge and lukewarm water with a little washing-up liquid to clean the surfaces of the appliance.

## Preparing the refrigeration appliance for cleaning

- Switch the refrigeration appliance off.
- Take any food out of the refrigeration appliance and store it in a cool place.
- Take out all other removable parts for cleaning.

## Cleaning the inside of the appliance

The refrigeration appliance should be cleaned regularly (at least once a month).

If soiling is left on for any length of time, it may become impossible to remove under certain circumstances. Surfaces may suffer discolouration or damage.

It is therefore best to remove any soiling immediately.

- Clean the **interior** with a clean sponge, lukewarm water and a little washing-up liquid.
- After cleaning, wipe with clean water and dry with a cloth.
- Leave the door open to air the refrigeration appliance sufficiently for a short while and to prevent odour build-up.

## Cleaning accessories by hand or in the dishwasher

The following components must be cleaned **by hand** only:

- All drawers

The following components are **dishwasher-safe**:

 Risk of damage due to high dishwasher temperatures. Parts of the refrigeration appliance may become unusable, e.g. deform, if they are washed in the dishwasher at more than 55 °C. For dishwasher-safe components, always select dishwasher programmes with a maximum temperature of 55 °C.

Contact with natural dyes from carrots, tomatoes and ketchup, etc., may discolour the plastic parts in the dishwasher. This discolouration does not affect the stability of the parts.

- The ice cube tray

## Removing and dismantling accessories for cleaning

### Taking out the freezer drawers

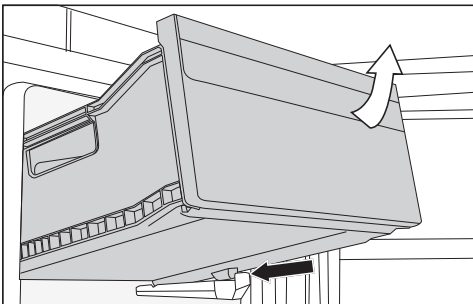

- Lift the freezer drawers at the front and pull them up and out at an angle.

### Inserting the freezer drawers

- Insert the freezer drawers back in the freezer zone at an angle.

## Cleaning the door seal

 Risk of damage as a result of incorrect cleaning.

If you treat the door seal with oils or grease, it can become porous. Do not use any oils or grease on the door seal.

- The door seal should be cleaned regularly with clean water, and then wiped dry with a soft cloth.

## Cleaning the ventilation gaps

A build-up of dust will increase the energy consumption of the appliance.

- The ventilation gaps should be cleaned on a regular basis with a brush or vacuum cleaner (you could use a Miele vacuum cleaner dusting brush, for example).

## After cleaning

- Close the appliance door.
- Switch the refrigeration appliance back on.
- Switch on the SuperFreeze function so that the refrigeration appliance can cool down quickly.
- Once the temperature in the refrigeration appliance is sufficiently low, place the frozen food back in the freezer drawers and put them back in the refrigeration appliance.
- Switch the SuperFreeze function off again.

## Cleaning and care

---

### Defrosting

The appliance is equipped with a “NoFrost” system. The refrigeration appliance defrosts automatically.

The moisture generated in the appliance collects on the condenser and is automatically defrosted and dissipated from time to time.

This automatic defrosting system enables the freezer to remain permanently ice-free. Food stored in the freezer will not defrost with this system.

Many malfunctions and faults can be easily remedied. You can save time and money in many cases, as you do not need to contact Customer Service.

More information to help you remedy faults yourself can be found at [www.miele.co.uk/support/customer-assistance](http://www.miele.co.uk/support/customer-assistance).



To prevent unnecessary loss of temperature it is advisable not to open the door while waiting for the appliance to be serviced.

Problem	Cause and remedy
<p><b>The compressor is switching on more frequently and for longer periods of time. The temperature in the refrigeration appliance is too low.</b></p>	<p>The ventilation gaps have been covered or become too dusty.</p> <ul style="list-style-type: none"> <li>■ Do not block the ventilation gaps.</li> <li>■ Dust the ventilation gaps regularly.</li> </ul>
	<p>The appliance door has been opened too frequently, or a large amount of fresh food has been placed inside or frozen at the same time.</p> <ul style="list-style-type: none"> <li>■ Only open the appliance door when necessary and for as short a time as possible.</li> </ul> <p>After a while, the temperature will return to normal by itself.</p>
	<p>The appliance door is not properly closed. A thick layer of ice may have formed in the freezer section.</p> <ul style="list-style-type: none"> <li>■ Close the appliance door.</li> </ul> <p>After a while, the temperature will return to normal by itself.</p> <p>If a thick layer of ice has already formed, this will affect cooling and increase energy consumption.</p> <ul style="list-style-type: none"> <li>■ Defrost the refrigeration appliance and clean it.</li> </ul>
	<p>The ambient temperature is too high. The higher the ambient temperature, the longer the compressor runs.</p> <ul style="list-style-type: none"> <li>■ See the information in “Installation – Installation site”.</li> </ul>
	<p>The refrigeration appliance was not properly installed in the niche.</p>



















# Troubleshooting

Problem	Cause and remedy
	<ul style="list-style-type: none"> <li>■ Install the refrigeration appliance in the niche as described in the installation instructions supplied with it.</li> </ul> <p>The temperature setting in the refrigeration appliance is too low.</p> <ul style="list-style-type: none"> <li>■ Correct the temperature setting.</li> </ul> <p>A large amount of food is being frozen at once.</p> <ul style="list-style-type: none"> <li>■ See “Freezing and storing food”.</li> </ul> <p>The SuperFreeze function ❄️ is still switched on.</p> <ul style="list-style-type: none"> <li>■ Switch off the SuperFreeze function ❄️ earlier to save energy.</li> </ul>



## Other problems



Problem	Cause and remedy
<p><b>There is no audible alarm even though the appliance door has been open for a long time.</b></p>	<p>This is not a fault. The alarm has been switched off in Settings mode. If you want to switch the audible alarm back on again:</p> <ul style="list-style-type: none"> <li>■ Tap ❄️.</li> <li>■ Swipe left or right until 🔊 is shown in the middle.</li> <li>■ Tap 🔊.</li> <li>■ Select the volume you want by swiping the segment bar to the right.</li> <li>■ Confirm the setting you want by tapping the segment bar.</li> </ul> <p>When the alarms and buzzers are switched on, 🔊 orange will appear.</p>
<p><b>The external walls of the appliance feel warm.</b></p>	<p>This is not a fault. The heat created by the evaporator is used to prevent condensation.</p>

## Display warnings





Message	Cause and remedy
<p> lights up on the start display, the refrigeration appliance does not get cold even though the controls and the interior lighting are working.</p>	<p>Demo mode has been activated.</p> <ul style="list-style-type: none"> <li>■ Tap .</li> <li>■ Tap .</li> <li>■ Swipe left or right until  is shown in the middle.</li> <li>■ Tap .</li> </ul> <p>After Demo mode  has been switched off, the refrigeration appliance shuts down and must be switched on again.</p>
<p>Nothing is visible in the display. The display is completely blank.</p>	<p>Sabbath mode  is switched on: the interior lighting is switched off and the refrigeration appliance is cooling.</p> <ul style="list-style-type: none"> <li>■ Tap the black display.</li> </ul> <p> will appear in the display.</p> <ul style="list-style-type: none"> <li>■ Tap .</li> </ul> <p> will light up orange.</p> <ul style="list-style-type: none"> <li>■ Tap  again.</li> </ul> <p>When Sabbath mode is switched off,  will light up white.</p>
<p> is lit up on the display and the appliance cannot be used.</p>	<p>The lock function has been activated.</p> <ul style="list-style-type: none"> <li>■ Unlock the refrigeration appliance temporarily or switch the lock function off completely (see “Selecting further settings – Deactivating the lock function / temporarily/switching off completely”).</li> </ul>
<p> will light up yellow in the display, an alarm will also sound and the interior lighting will flash.</p>	<p>The <b>door alarm</b> has been activated.</p> <ul style="list-style-type: none"> <li>■ Tap .</li> </ul> <p>The alarm will stop,  will go out and the interior lighting will light up again constantly.</p>

# Troubleshooting



Message	Cause and remedy
<p> is lit up red in the temperature display and an alarm is also sounding.</p>	<p>The temperature alarm has been activated; the temperature in the freezer section has risen higher or fallen lower than the temperature set.</p> <p>Possible reasons for this include:</p> <ul style="list-style-type: none"> <li>– The appliance door has been opened too frequently.</li> <li>– A large quantity of fresh food has been placed in the freezer without the SuperFreeze function being switched on.</li> <li>– A prolonged power cut (mains outage) has occurred.</li> <li>– The refrigeration appliance has a fault.</li> </ul> <p>■ Tap .</p> <p>The alarm message is confirmed:  goes out and the alarm stops.</p> <p>The warmest temperature recorded in the refrigeration appliance will flash for about 1 minute in the display. Then the temperature display will change to the current temperature.</p> <p>You can exit from the flashing temperature display early:</p> <p>■ Touch the temperature display.</p> <p>The warmest temperature displayed will disappear. The display will then revert to showing the current temperature in the freezer.</p> <p>■ Rectify the cause of the alarm.</p> <p>■ Depending on the temperature displayed, you should check whether food in the freezer has started to thaw or has defrosted. If it has, it should be used as soon as possible. Defrosted food may only be re-frozen after it has been cooked.</p>







Message	Cause and remedy
<p> lights up red in the display and an alarm also sounds.</p>	<p>Indication of an interruption to the power supply: the temperature in the refrigeration appliance over the last few days or hours has risen too high because of a power cut or interruption to the power supply.</p> <ul style="list-style-type: none"> <li>■ Tap .</li> </ul> <p>The fault message is confirmed:   goes out and the alarm will stop.</p> <p>The warmest temperature recorded in the refrigeration appliance will flash for about 1 minute in the display. Then the temperature display will change to the current temperature.</p> <p>You can exit from the flashing temperature display early:</p> <ul style="list-style-type: none"> <li>■ Touch the temperature display.</li> </ul> <p>The warmest temperature displayed will disappear. The display will then revert to showing the current temperature. The refrigeration appliance will go back to the last temperature setting when the power is back on.</p> <ul style="list-style-type: none"> <li>■ Rectify the cause of the alarm.</li> <li>■ Depending on the temperature displayed, you should check whether food in the freezer has started to thaw or has defrosted. If it has, it should be used as soon as possible. Defrosted food may only be re-frozen after it has been cooked.</li> </ul>

# Troubleshooting

Message	Cause and remedy
<p> <b>lights up red in the display and a fault code F with numbers may appear. An alarm is also sounding.</b></p>	<p>There is a fault.</p> <ul style="list-style-type: none"> <li>■ Tap  on the display to switch the alarm off.</li> <li>■ Contact the Miele Customer Service Department.</li> </ul> <p>To report the fault, you need the fault code and also the model identifier and serial number of your refrigeration appliance. You can access this information on the display:</p> <ul style="list-style-type: none"> <li>■ To do this, touch  on the display.</li> </ul> <p>The appliance data required will be shown on the display.</p> <p>Confirm with  to exit the information display and the fault code will be shown again on the display.</p> <p>The refrigeration appliance can be switched off directly from the fault message display.</p> <hr/> <p>There is an appliance fault: this display always has priority over any settings which have just been selected.</p> <p>An appliance fault has priority over any current door and/or temperature alarms displayed.</p>

## Interior lighting

Problem	Cause and remedy
<p> Risk of electric shock due to exposed, live electrical components.</p> <p>When removing the lighting cover, there is a risk of coming into contact with live electrical components.</p> <p>Do not remove the lighting cover. The LED lighting may only be repaired or replaced by the Miele Customer Service Department.</p>	
<p> Risk of injury from LED lighting.</p> <p>This lighting corresponds to risk group RG 2. If the cover is defective, there is a risk of eye injury.</p> <p>If the lighting cover is defective, do not look from a close range directly into the lighting with optical instruments (e.g. magnifying glass or similar).</p>	

Problem	Cause and remedy
<p><b>The interior lighting is not working.</b></p>	<p>The refrigeration appliance has not been switched on.</p> <ul style="list-style-type: none"> <li>■ Switch the refrigeration appliance on.</li> </ul>
	<p>Sabbath mode  is switched on: the display is dark and the refrigeration appliance is cooling.</p> <ul style="list-style-type: none"> <li>■ Tap on the black display.</li> </ul> <p> will appear on the display.</p> <ul style="list-style-type: none"> <li>■ Tap .</li> </ul> <p> lights up orange.</p> <ul style="list-style-type: none"> <li>■ Tap on the  symbol in Settings mode .</li> </ul> <p>When Sabbath mode is switched off, the  symbol will light up white.</p>
	<p>To avoid overheating, the lighting switches itself off automatically after approx. 15 minutes if the appliance door is left open. If this is not the case, then there is a fault.</p> <ul style="list-style-type: none"> <li>■ Call the Miele Customer Service Department.</li> </ul>

# Customer Service Department

Information to help you rectify faults yourself and about Miele spare parts can be found at [www.miele.com/service](http://www.miele.com/service).

## Contact in the event of a fault

In the event of a fault which you cannot remedy yourself, please contact your Miele dealer or Miele Customer Service.

You can book a Miele Customer Service call-out online at [www.miele.com/service](http://www.miele.com/service).

Contact information for Miele Customer Service can be found at the end of this document.

Please quote the model identifier and serial number of your appliance (SN) when contacting Miele Customer Service. Both numbers can be found on the data plate inside the refrigeration appliance or, depending on the model, in Settings mode under Information **i**.

## EPREL database

Since 1 March 2021, information on energy labelling and ecodesign requirements has been available in the European Product Database (EPREL). You can find the product database at the following link <https://eprel.ec.europa.eu/>. You will be asked to enter the model identifier.

The model identifier can be found on the data plate inside the refrigeration appliance or, depending on the model, in Settings mode under Information **i**.

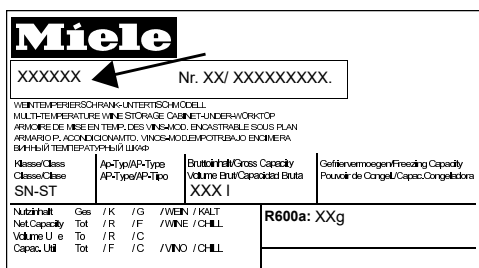

## Warranty

For information on the appliance warranty specific to your country please contact Miele. See back cover for address.

In the UK, your appliance warranty is valid for 2 years from the date of purchase. However, you must activate your cover by calling 0330 160 6640 or registering online at [www.miele.co.uk](http://www.miele.co.uk).

### **Multi-purpose microfibre cloth**

The microfibre cloth is suitable for removing fingerprints and light soiling from surfaces such as stainless steel, glass, plastic and chrome without the use of chemicals.

### **MicroCloth Kit**

The MicroCloth Kit contains a universal cloth, a glass cloth and a polishing cloth. These cloths are extremely resistant to tearing and very robust. Thanks to very fine microfibres these cloths achieve an excellent cleaning performance.

### **MicroCloth HyClean**

The MicroCloth HyClean is a multi-purpose antibacterial cloth and is particularly tear resistant and durable. It can be used wet or dry, with or without cleaning agent.

Optional accessories can be ordered from the Miele webshop. They can also be ordered from the Miele Customer Service Department (see end of this booklet for contact details) or from your Miele dealer.

# Installation

## Installation site

 Risk of damage and danger of injury due to the refrigeration appliance tipping over.

This refrigeration appliance is very heavy and can tip forwards when the appliance door is open.

Keep the appliance door(s) closed until the refrigeration appliance has been built in. The refrigeration appliance must be secured in its building-in niche in accordance with the operating and installation instructions.

 Fire risk and risk of damage from appliances which give off heat.

Appliances which give off heat can catch fire and set fire to the refrigeration appliance.

This refrigeration appliance must not be installed underneath a hob.

 Fire risk and danger of damage from open flames.

Open flames can set fire to the refrigeration appliance.

Keep open flames (e.g. a candle) away from the refrigeration appliance.

 Risk of damage caused by appliances discharging vapours.

Installing appliances that discharge vapours behind the refrigeration appliance will put it at risk of damage.

Do not install appliances that discharge air or vapours behind the refrigeration appliance. Provide a separate air guide or install a partition wall between the appliances.

This appliance should be installed in a dry, well-ventilated room.

 Risk of damage due to high humidity.

In environments with high humidity, condensation can build up on external refrigeration appliance panels.

This condensate can cause corrosion on external appliance panels.

Install the refrigeration appliance in a dry and/or air-conditioned room with sufficient ventilation.

After installation please make sure that the appliance door(s) closes (close) properly and the refrigeration appliance is installed in accordance with these installation instructions. It is essential to comply with the specified ventilation cutout requirements.

When deciding on the installation site, please bear in mind that your refrigeration appliance will use more energy if installed near to a heater, a cooker or another appliance that gives off heat. Avoid direct sunlight. The higher the ambient temperature, the longer the compressor runs and the higher the energy consumption is.

When installing the refrigeration appliance, please note the following:

- The socket must be easily accessible in an emergency, not concealed behind the appliance.
- The mains plug and mains connection cable must not touch the rear of the refrigeration appliance as they could be damaged by vibrations from the appliance.

- Other appliances must also not be plugged into a socket located directly behind the refrigeration appliance.
- When installing the refrigeration appliance, make sure that the mains connection cable does not get trapped or damaged.
- Do not position or operate multi-socket adapters, distributor strips or other electronic devices (e.g. halogen transformers) at the rear of the appliance.
- The floor at the installation site must be horizontal and level and must be as high as the surrounding floor.

## Climate range

This refrigeration appliance is designed for use within specific ambient temperatures (climate range). Do not use in ambient temperatures for which it is not designed.

A lower ambient temperature leads to the compressor switching off for longer periods. This can cause the internal temperature in the refrigeration appliance to rise with the risk of food deteriorating and going off.

The climate range is stated on the data plate in the interior cabinet of the refrigeration appliance.

Climate range	Ambient temperature
SN	10 to 32 °C
N	16 to 32 °C
ST	16 to 38 °C
T	16 to 43 °C
SN-ST	10 to 38 °C
SN-T	10 to 43 °C

A refrigeration appliance from the SN climate range can operate without any difficulties in rooms with a cooler ambient temperature (down to +5 °C).

## Ventilation

Ventilation takes place through a ventilation grille in the refrigeration appliance plinth.



Risk of fire and damage due to insufficient ventilation.

If the refrigeration appliance is not ventilated sufficiently, the compressor will run more frequently and for longer periods. This will result in increased energy consumption and a higher operating temperature for the compressor. This may, in turn, cause damage to the compressor. Please ensure that there is adequate ventilation around the refrigeration appliance.

It is essential to observe the required ventilation gaps.

The ventilation gaps must not be covered or blocked in any way.

They must also be regularly dusted.

# Installation

## Side-by-side installation

 Risk of damage due to condensation on external appliance panels.

In environments with high humidity, condensation can build up on external appliance panels, which can cause corrosion.

Do not place different refrigeration appliance models directly next to or on top of one other.

However your refrigeration appliance can be installed “side-by-side” because it is equipped with built-in heating units in the side panels.

Please contact your dealer for specific information about which combinations will work with your appliance.

## Changing the door hinging

 Danger of injury and damage to the appliance due to heavy door.

There is an increased risk of injury and damage if the door hinging is installed by a single person.

Always change the door hinging with the help of a second person.

 Risk of crushing at the hinge.

Fingers can get trapped in or around the hinge.

Do not reach into the hinge when opening and closing the door.

The refrigeration appliance is supplied with right-hand hinging. If left-hand hinging is required, the hinges must be changed (see accompanying installation instructions) before the refrigeration appliance is installed in the niche.

**Tip:** Place a suitable cover on the floor in front of the refrigeration appliance to protect the appliance door and your floor from damage during door hinging.

Be careful not to damage the door seal. If the door seal is damaged, the appliance door may not close properly and cooling will be insufficient.

## Furniture door panel

### – Gap

Depending on the style of kitchen furniture, the thickness and edge radius of the furniture door and the gap that runs around the door, vertically and horizontally, are specified.

It is essential to pay attention to the following:

If the gap between the refrigeration appliance furniture door panel and the adjoining housing unit door or wall on the hinged side is too small, the appliance door could collide with the adjoining housing unit door or wall when opened.

It may be necessary to adjust the size of this gap to suit the thickness and edge radius of the appliance furniture door.

**Tip:** This must be taken into consideration when planning your kitchen and when replacing an old refrigeration appliance with a new one to ensure the installation conditions required are met.

Appliance furniture door thickness <b>A</b> [mm]	Gap <b>X</b> [mm] for different edge radii <b>B</b>			
	R0	R1.2	R2	R3
≥16–19	min. 3			
20	5	4	4	3.5
21	5.5	5	4.5	4
22	6.5	6	5.5	5

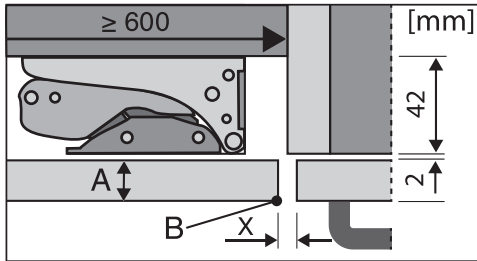

Adjoining kitchen furniture front

A = Furniture front thickness

B = Edge radius

X = Gap

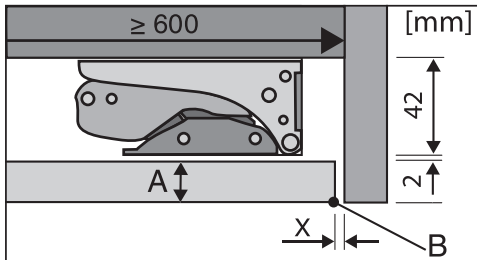

Adjoining side wall

A = Furniture front thickness

B = Edge radius

X = Gap

**Tip:** Fit a spacer between the housing unit carcase and the side wall. This way you will get a sufficiently wide gap.

## Weight of the furniture door

⚠ If the furniture door panel is too heavy, this can cause damage. Fitting a furniture front which is heavier than the maximum permitted weight could damage the hinges. This damage can affect various factors, such as operation of the appliance. Before fitting a furniture door, ensure that the weight of the door does not exceed the maximum permitted.

The maximum permissible weight of the furniture door is 10 kg.

## Limiting the opening angle of the appliance door

The door hinges are set ex works to enable the appliance door to be opened wide.

If the opening angle of the appliance door needs to be limited to approx. 90°, the hinge can be adjusted to accommodate this.

The locking pins for limiting the door opening must be fitted before the refrigeration appliance is installed.

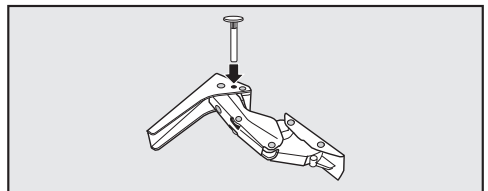

- Insert the locking pins supplied for limiting the door opening into the hinges from above.

The appliance door opening angle is now limited to approx. 90°.

# Installation

## Building-in dimensions

### Niche/side view

All dimensions are given in mm.

The refrigeration appliance will function correctly if the specified ventilation openings are kept clear.

### FNUS 7040

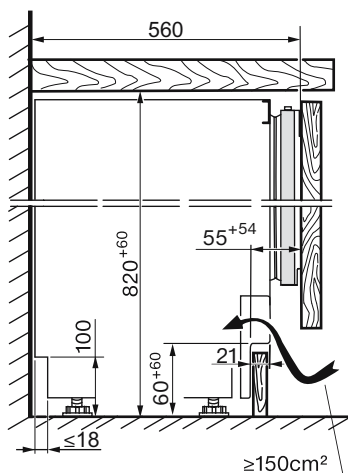
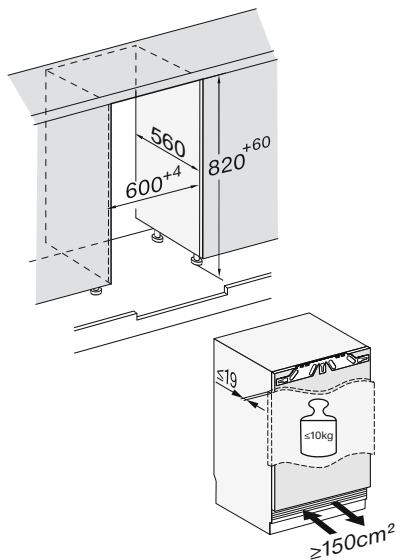



# Installation

## Connections

All dimensions are given in mm.

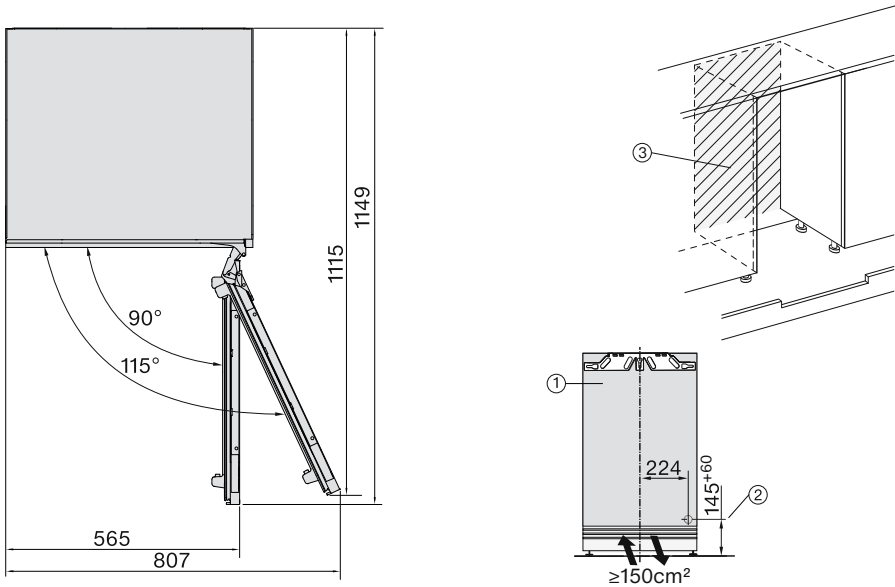

- ① View from the front
- ② Mains connection cable, length = 2200 mm  
A longer mains connection cable is available to order from the Miele Customer Service Department.
- ③ No connection sockets in this area

## Installing the appliance

To install the refrigeration appliance, you will need the following tools:

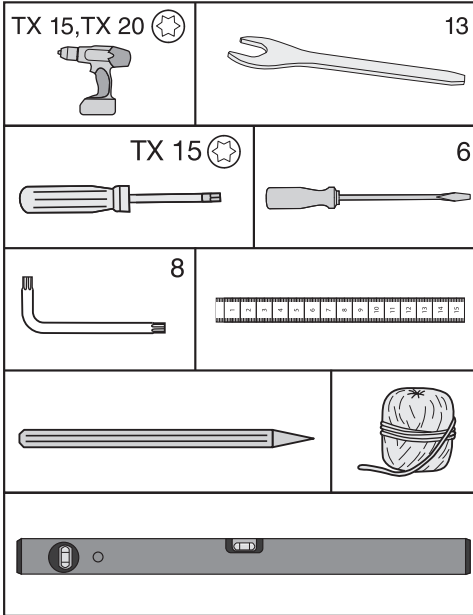

**Tip:** Store the enclosed metal rod in a safe place. It is required for adjusting the rear appliance feet.

### Preparing the refrigeration appliance

- Position the refrigeration appliance in front of the niche.
- Hold the plinth panel at the side and pull it forwards and off.

You have a choice of two different ways of securing your refrigeration appliance:

1. Secured at the top  
This method is suitable for securing the appliance underneath a plastic worktop, e.g., laminate. The worktop must be suitable for screwing a fixing bracket onto.

With the appliance feet fully extended the appliance should sit lightly tensioned between the floor and the worktop.

2. Secured at the side  
This method is suitable for securing the appliance underneath a solid worktop, e.g. granite. The furniture side walls to the right and left of the refrigeration appliance must be suitable for screwing fixing brackets to.  
With the feet fully extended the refrigeration appliance will sit lower than the worktop.

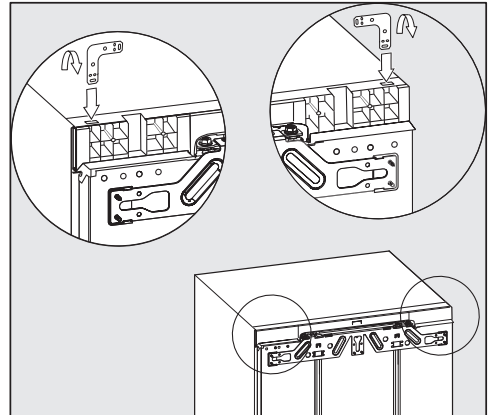

1. Secured at the top
  - Fit the bracket in the opening in the appliance lid.
  - Bend the bracket at the perforated position.

# Installation

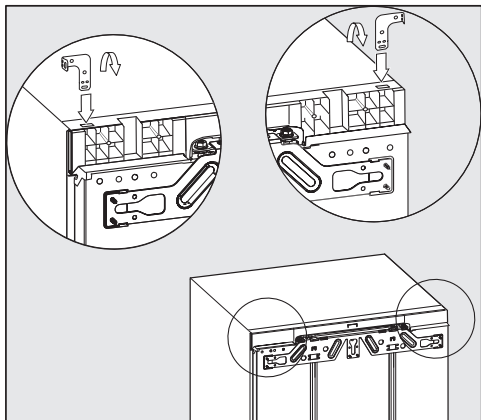

## 2. Secured at the side

Both ends of the bracket must be bent.

- Fit the bracket in the opening in the appliance lid.
- Bend the bracket at the perforated position.
- Remove the bracket from the opening and insert the straight end of the bracket.
- Now bend this end of the bracket at the perforated position.

## Positioning the refrigeration appliance

**⚠** Risk of damaging the mains connection cable.

When pushing the refrigeration appliance into its niche, the mains connection cable can get trapped and damaged.

Carefully push the refrigeration appliance into the niche.

**⚠** Risk of damaging the floor.  
Moving the refrigeration appliance can cause damage to the floor.  
Move the refrigeration appliance carefully on floors that are sensitive to scratching.

**⚠** Risk of damaging the appliance feet.  
The appliance feet can break off.  
The feet should be almost fully screwed in when you push the refrigeration appliance into the niche.

**Tip:** Before pushing the appliance into the niche the two rear feet should be loosened by half a turn. After pushing it into the niche, the feet will be easier to adjust from the front (see “Aligning the refrigeration appliance”).

- Position the mains connection cable so that the refrigeration appliance can be connected easily once installed.

**Tip:** To help you push it into position, tie a piece of string around the plug to “lengthen” the mains connection cable. Then pull the mains connection cable by the end of the string through the housing unit.

If the refrigeration appliance is pushed too far into the niche, the appliance door may not close properly once the furniture panel has been fitted. This can cause ice to build up, condensate to accumulate and lead to faults in the appliance. These can all lead to increased energy consumption.

Push the refrigeration appliance into the niche, making sure a gap of **42 mm** is maintained all round between the appliance carcass and the front of the housing unit side walls.

- Push the refrigeration appliance into the niche until the front edges of the hinges at the top and bottom are flush with the front edge of the housing unit side wall.

This will create a gap all round of **42 mm** to the front edges of the housing unit side walls.

**On furniture with door fittings (e.g. stubs, seals, etc.),** the dimension of these must be taken into account to ensure there is a gap all round of **42 mm**.

- Pull the refrigeration appliance forwards by the appropriate dimension.
- Check again to make sure there is a gap of **42 mm** to the front edges of the door fittings.

**Tip:** If possible, remove the door fittings and push the refrigeration appliance into the niche until all fixing brackets at the top and bottom are touching the front edge of the housing unit side wall.

## Aligning the refrigeration appliance

When securing the refrigeration appliance in the niche at the top, it should sit lightly tensioned between the floor and the worktop.

- Adjust the front and rear feet alternately according to the niche height and make sure the refrigeration appliance is correctly aligned.

### Proceed as follows:

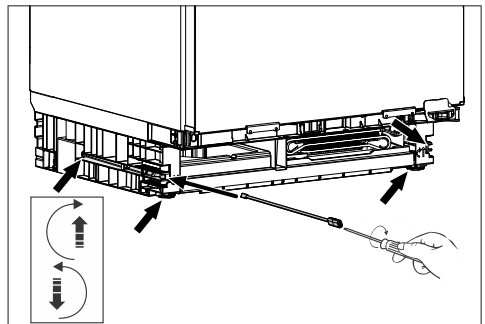

- Adjust both rear feet with appropriate screws at the front right and left in the appliance plinth using the rod supplied and a flat-head screwdriver.
- Unscrew the two front levelling feet alternately with the rear ones. The maximum adjustment range is 6 cm.

**Tip:** As soon as the feet have been unscrewed slightly, you can adjust them with a screwdriver at the bottom of the foot (see small illustration).

The foam ① attached to the ventilation grille ensures the airflow is separated to prevent malfunctioning of the appliance.

# Installation

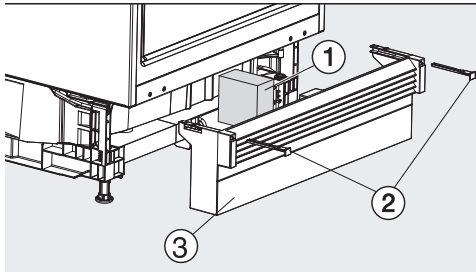

- Replace the plinth panel with the ventilation grille (3), but do not fix it in place yet.

## Without a continuous plinth facing:

- Pull the plinth panel (3) forwards until the ventilation slots are in alignment with adjacent cabinet plinth panels.

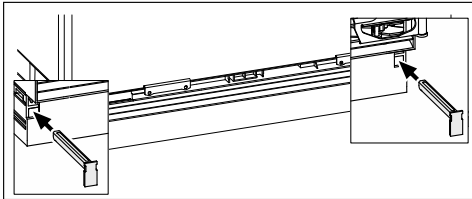

- Hold the plinth panel securely and attach it to the right and left using the bolts supplied (2).

With the plinth panel attached, the rear feet can only be adjusted when the plinth panel is fully inserted. Otherwise, the bar is not long enough.

## With a continuous plinth facing:

- Push the plinth panel with the ventilation grille (3) right up against the refrigeration appliance, and attach it to the right and left using bolts (2).

If a continuous plinth facing is to be fitted, a suitable ventilation gap will need to be made in it for the ventilation grille of the refrigeration appliance.

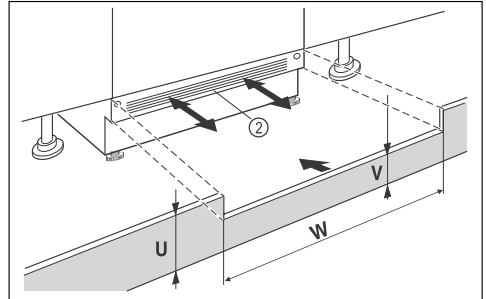

- Trim the furniture plinth facing (U) to the correct height.
- Adjust the height (V) along the niche width (W) underneath the appliance plinth facing (2).

## Securing the refrigeration appliance in the niche

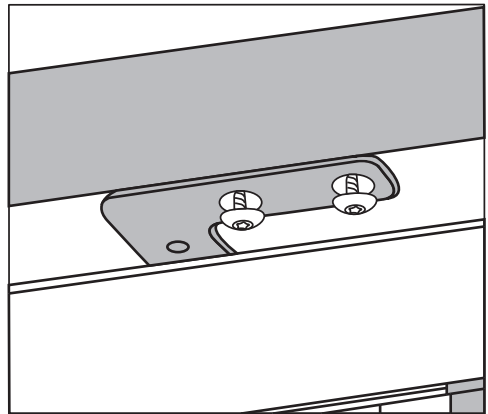

1. Secured at the top
- Screw the refrigeration appliance in place underneath the worktop with two screws in each case.

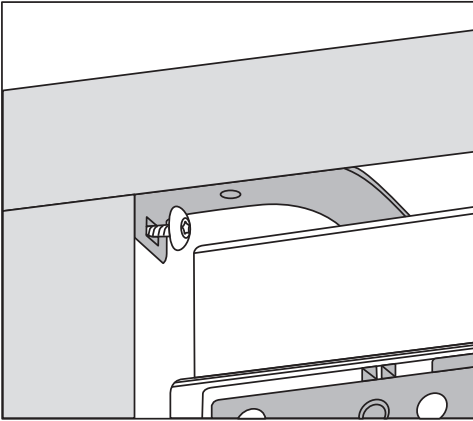

## 2. Secured at the side

- Screw the refrigeration appliance into the niche on the right and left with one screw in each case.

## Fitting the furniture door

If fitted in a run of units make sure that the top edge of the furniture door is at the same height as neighbouring unit doors.

The furniture door must be fitted correctly and not under tension.

The next section gives instructions on how to fit a furniture door that is at least 16–19 mm thick.

Ensure that the plinth panel is refitted correctly.

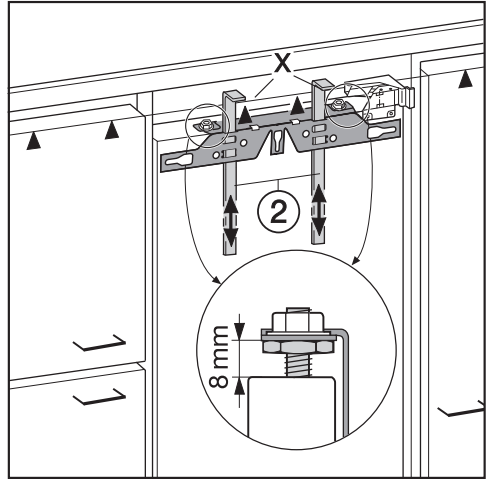

- The distance between the appliance door and the fixing bracket is set to 8 mm at the factory. Check this distance and adjust it if necessary.
- Push the fitting aids ② up to the height of the furniture door: the lower edge X of the fitting aids must be at the same height as the upper edge of the furniture door being fitted (see ▲ in diagram).

# Installation

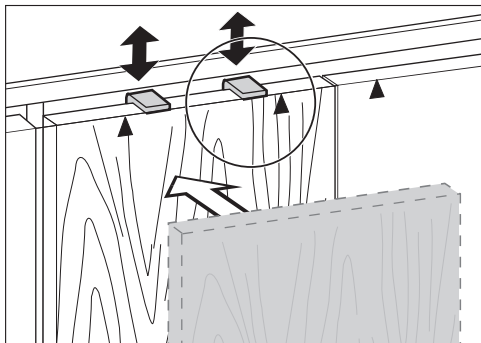

**Tip:** Push up the fitting aids ② with the furniture front until they are the same height as the doors of adjacent kitchen units.

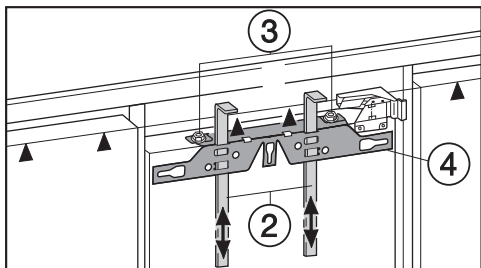

■ Undo the nuts ③ and take the fixing bracket ④ off together with the fitting aids ②.

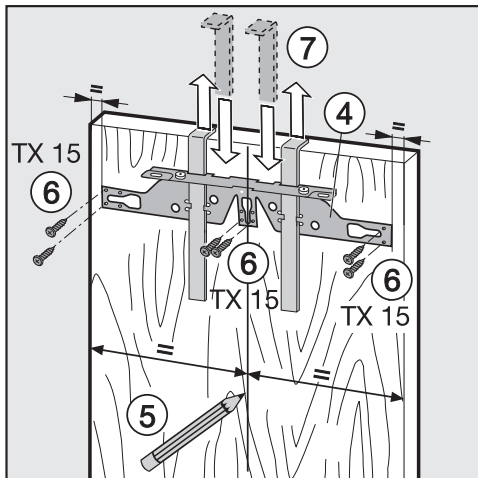

- Using a pencil, lightly mark a line down the centre of the inside of the furniture door ⑤.
- Hang the fixing bracket ④ with the fitting aids onto the **inside** of the furniture door. Align the fixing bracket centrally.
- Attach the fixing bracket securely using at least 6 short chipboard screws ⑥. (On cassette doors only use 4 screws on the edges.) Drill holes into the furniture door if necessary.
- Pull the fitting aids upwards to remove them ⑦. Turn them around and fit them into the middle slots on the fixing bracket for safe keeping.

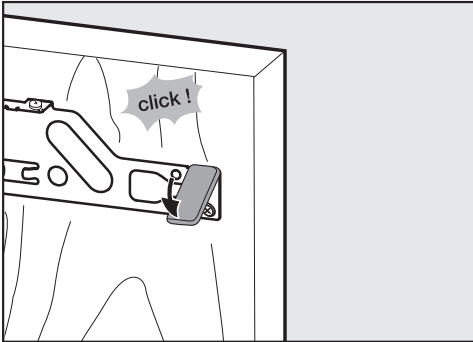

- Fit the side cover to the fixing bracket on the opposite side of the hinge.
- Turn the furniture door over and attach the handle (if required).
- Open the appliance door.

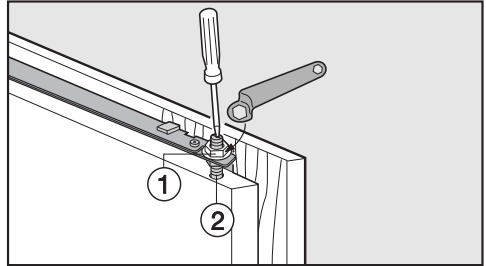

- Whilst counterholding adjusting bolts (2) with a screwdriver, tighten nuts (1) on the appliance door with screwdriver.

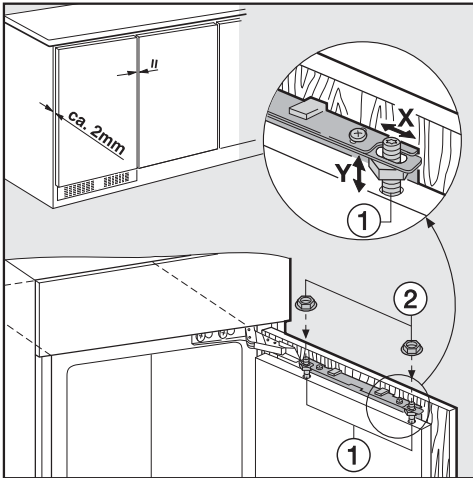

- Hang the furniture door onto the adjusting bolts (1).
- Loosely attach the nuts (2) on the adjusting bolts.
- Close the door and check the distance between the door and neighbouring furniture doors.
- Align to match neighbouring doors if necessary:  
Side adjustments X are made by

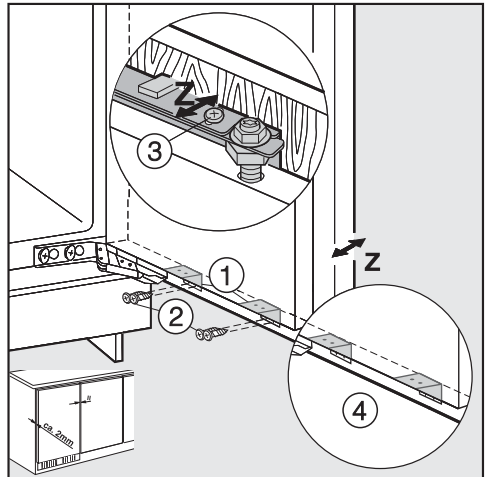

- Attach the appliance door and the furniture door using screws through fixing brackets (1):
  - Drill holes in the furniture door (mark the position of the holes first).
  - Screw in the short chipboard screws (2) (4 x 14 mm).
- Align the furniture door along the depth plane Z: loosen the screws in the long slots at the top of the

# Installation

---

appliance door ③ as well as under the appliance door ④. By moving the furniture door, create a gap of 2 mm between the furniture door and the front edge of the niche. Align according to the adjacent furniture doors.

- Close the door, check it is secured correctly, and align it with adjacent furniture doors.
- Tighten all the screws again.

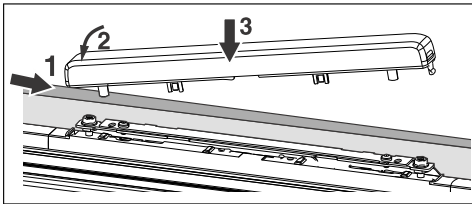

- Replace the cover and click it into place.

## To make sure the appliance is correctly fitted:

- The door must close properly.
  - The door must not touch the housing unit.
  - The seal at the top edge of the handle side must fit properly.
- To double check place a torch in the appliance and close the door. Turn the lights out in the room. If you can see any light shining out from the sides double check the installation.

## Electrical connection

The refrigeration appliance must only be connected to an earthed socket using the mains connection cable supplied.

The socket must be easily accessible after the refrigeration appliance has been installed. If the socket is not easily accessible, ensure that a suitable means of disconnection is provided on the installation side for each pole.

 Risk of fire from overheating.

Connecting the refrigeration appliance to a multi-socket plug adapter or to an extension lead can overload the cable.

For safety reasons, do not use an extension lead or multi-socket adapter.

The electrical installation must comply with VDE 0100 requirements.

For safety reasons, we recommend using a type  residual current device (RCD) in the assigned electrical installation for connecting the refrigeration appliance.

If the mains connection cable is damaged, it must only be replaced with a specific mains connection cable of the same type (available from the Miele Customer Service Department). For safety reasons, such replacement may only be carried out by a qualified specialist or the Miele Customer Service Department.

These operating instructions and the data plate indicate the nominal power consumption and the appropriate fuse rating. Compare this information with the data of the on-site electrical connection. If in any doubt, consult a qualified electrician.

Temporary or permanent operation on an autonomous power supply system or a power supply system that is not synchronised with the mains power supply (e.g. island networks, back-up systems) is possible. A prerequisite for operation is that the power supply system complies with the specifications of EN 50160 or an equivalent standard. The function and operation of the protective measures provided in the domestic electrical installation and in this Miele product must also be maintained in isolated operation or in operation that is not synchronised with the mains power supply, or these measures must be replaced by equivalent measures in the installation. As described, for example, in the current version of VDE-AR-E 2510-2.

## Connecting the refrigeration appliance

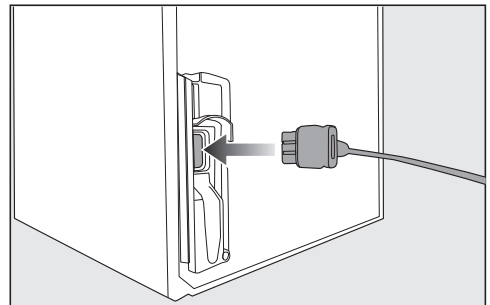

- Insert the plug connector into the socket at the back of the refrigeration appliance.

Make sure that the plug connector has clicked into position correctly.

- Insert the plug of the refrigeration appliance into the socket.

The refrigeration appliance is now connected to the electricity supply.

# EU Conformity declaration

---

Miele hereby declares that this freezer complies with Directive 2014/53/EU.

The complete text of the EU declaration of conformity is available from one of the following internet addresses:

- Products, Download from [www.miele.ie](http://www.miele.ie)
- For service, information, operating instructions etc: go to <https://miele.co.uk/manuals> and enter the name of the product or the serial number

Frequency band of the WiFi module	2.4000 GHz – 2.4835 GHz
-----------------------------------	-------------------------

Maximum transmitting power of the WiFi module	< 100 mW
---	----------

# UK Conformity declaration

Miele hereby declares that this freezer complies with UK Radio Equipment Regulations 2017, as amended.

The complete text of the UK declaration of conformity is available from one of the following internet addresses:

- Products, Download from [www.miele.co.uk](http://www.miele.co.uk)
- For service, information, operating instructions etc: go to <https://miele.co.uk/manuals> and enter the name of the product or the serial number

Frequency band of the WiFi module	2.4000 GHz – 2.4835 GHz
-----------------------------------	-------------------------

Maximum transmitting power of the WiFi module	< 100 mW
---	----------

This **Statement of Compliance** confirms this Miele product fully complies with the **Product Security and Telecommunications Infrastructure (Security Requirements for Relevant Connectable Products) Regulations 2023**.

- 1) Household Appliance – *Freezer - 120002, 120003, 320001, 320002*  
*Refrigerator - 110001, 110002, 310001, 310002, 310003*  
*Fridge-freezer - 130001, 130002, 130003, 130004, 330001, 330002*  
*Wine unit - 210007, 310004, 330004*
- 2) Manufactured by: Miele & Cie KG,  
Carl Miele Street 29, 33332 Gutersloh Germany  
Imported by and contact point: Miele Company Ltd, Fairacres, Marcham Road, Abingdon, Oxon, OX14 ITW Great Britain
- 3) The defined support period at the time of first supply is 10 years
- 4) To report vulnerabilities and cybersecurity issues please contact: [psirt@miele.com](mailto:psirt@miele.com)

5) Signature 

Name: **Paul Wright**

Company Position: **Head of Technical Management**

Date of signature: **19th March 2024**

Place of signature: **Abingdon, Oxfordshire**

## Copyrights and licences

---

For the purpose of operating and controlling the communication module, Miele uses proprietary or third-party software that is not covered by open source licensing terms. This software/these software components are protected by copyright. The copyrights held by Miele and third parties must be respected.

Furthermore, the communication module integrated in the appliance contains software components which are distributed under open source licence conditions. The open source components contained in the appliance along with the corresponding copyright notices, copies of the licensing terms valid at the time and any further information can be accessed locally by IP via a web browser ([http\[s\]://<IP address>/Licenses](http[s]://<IP address>/Licenses)). The liability and warranty arrangements for the open source licences displayed in this location only apply in relation to the respective rights holders.





## United Kingdom

Miele Co. Ltd., Fairacres, Marcham Road, Abingdon, Oxon, OX14 1TW  
Tel: 0330 160 6600, Internet: [www.miele.co.uk](http://www.miele.co.uk), E-mail: [info@miele.co.uk](mailto:info@miele.co.uk)

### Australia

Miele Australia Pty. Ltd.  
ACN 005 635 398  
ABN 96 005 635 398  
Level 4, 141 Camberwell Road  
Hawthorn East, VIC 3123  
Tel: 1300 464 353  
E-mail: [info@miele.com.au](mailto:info@miele.com.au)  
Internet: [www.miele.com.au](http://www.miele.com.au)

### China Mainland

Miele Electrical Appliances Co. Ltd.  
No. 82, Shimenyi Road, JingAn District  
Shanghai, China, P.R.C  
Post Code: 200040  
Phone: +86 21 6157 3500  
Fax: +86 21 6157 3511  
E-mail: [info@miele.cn](mailto:info@miele.cn)  
Internet: [www.miele.cn](http://www.miele.cn)

### Hong Kong, China

Miele (Hong Kong) Ltd.  
41/F - 4101, Manhattan Place  
23 Wang Tai Road  
Kowloon Bay, Hong Kong  
Tel: (852) 2610 1025  
Fax: (852) 3579 1404  
E-mail:  
[customerservices@miele.com.hk](mailto:customerservices@miele.com.hk)  
Website: [www.miele.hk](http://www.miele.hk)

### India

Miele India Pvt. Ltd.  
1st Floor, Copia Corporate Suites,  
Commercial Plot 9, Mathura Road,  
Jasola, New Delhi - 110025  
E-mail: [customercare@miele.in](mailto:customercare@miele.in)  
Website: [www.miele.in](http://www.miele.in)

### Ireland

Miele Ireland Ltd.  
2024 Bianconi Avenue  
Citywest Business Campus  
Dublin 24  
Tel: (01) 461 07 10  
Fax: (01) 461 07 97  
E-mail: [info@miele.ie](mailto:info@miele.ie)  
Internet: [www.miele.ie](http://www.miele.ie)

### Malaysia

Miele Sdn Bhd  
Suite 12-2, Level 12  
Menara Sapura Kencana  
Petroleum  
Solaris Dutamas No. 1  
Jalan Dutamas 1  
50480 Kuala Lumpur, Malaysia  
Phone: +603-6209-0288  
Fax: +603-6205-3768

### New Zealand

Miele New Zealand Limited  
IRD 98 463 631  
8 College Hill  
Freemans Bay, Auckland 1011  
Tel: 0800 464 353  
E-mail: [customercare@miele.co.nz](mailto:customercare@miele.co.nz)  
Internet: [www.miele.co.nz](http://www.miele.co.nz)

### Singapore

Miele Pte. Ltd.  
29 Media Circle  
#11-04 ALICE@Mediapolis  
Singapore 138565  
Tel: +65 6735 1191  
Fax: +65 6735 1161  
E-mail: [info@miele.com.sg](mailto:info@miele.com.sg)  
Internet: [www.miele.sg](http://www.miele.sg)

### South Africa

Miele (Pty) Ltd.  
63 Peter Place, Bryanston 2194  
P.O. Box 69434, Bryanston 2021  
Tel: (011) 875 9000  
Fax: (011) 875 9035  
E-mail: [info@miele.co.za](mailto:info@miele.co.za)  
Internet: [www.miele.co.za](http://www.miele.co.za)

### Thailand

Miele Appliances Ltd.  
BHIRAJ TOWER at EmQuartier  
43rd Floor Unit 4301-4303  
689 Sukhumvit Road  
North Klongton Sub-District  
Vadhana District  
Bangkok 10110, Thailand

### United Arab Emirates

Miele Appliances Ltd.  
Showroom 1, Eiffel 1 Building  
Sheikh Zayed Road, Umm Al Sheif  
P.O. Box 114782 - Dubai  
Tel. +971 4 3044 999  
Fax. +971 4 3418 852  
800-MIELE (64353)  
E-mail: [info@miele.ae](mailto:info@miele.ae)  
Website: [www.miele.ae](http://www.miele.ae)

**Manufacturer:** Miele & Cie. KG, Carl-Miele-Straße 29, 33332 Gütersloh, Germany

FNUS 7040 ..., FNUS 7140 ...

en-GB

M.-Nr. 12 794 250 / 01